

*Electric Lubrication pump for fixed and mobile applications*

## User Operating and Maintenance Manual

Original Instructions

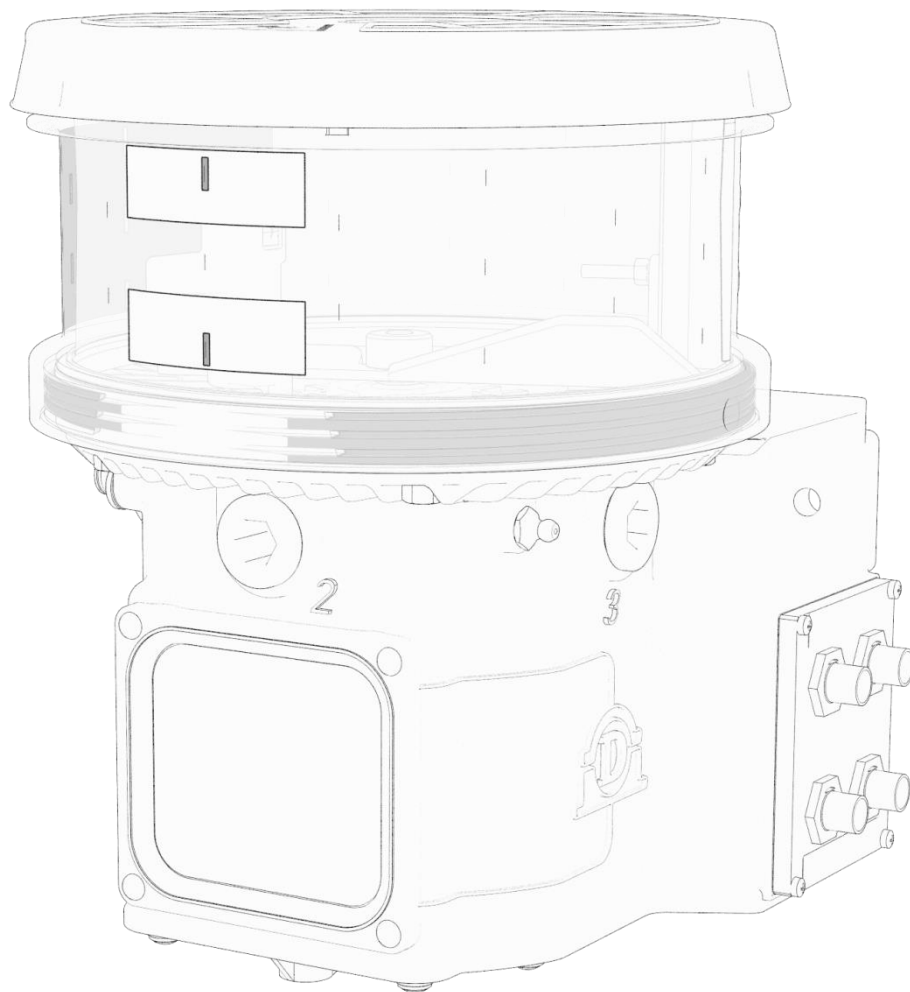

Manual drawn up in accordance with EC  
Directive 06/42

C2114IE WK 51/20

[www.dropsa.com](http://www.dropsa.com)

Dropsa products can be purchased from Dropsa branches and authorized distributors,  
visit [www.dropsa.com/contact](http://www.dropsa.com/contact) or contact us at [sales@dropsa.com](mailto:sales@dropsa.com)

## Sommario

1. INTRODUCTION.....	3
2. GENERAL DESCRIPTION.....	3
2.1 CENTRALIZED LUBRICATION – GENERAL OPERATING INFORMATION.....	3
2.2 BRAVO ELECTRIC GREASE PUMP .....	3
3. PRODUCT IDENTIFICATION .....	3
4. TECHNICAL CHARACTERISTICS .....	4
5.1 PUMPING UNITS IDENTIFICATION .....	6
5.1.1 ELECTRONIC CONTROL BOARD.....	6
5.2 MINIMUM LEVEL.....	6
5.3 CONNECTIONS & WIRING .....	6
6. UNPACKING AND INSTALLING.....	7
6.1 UNPACKING .....	7
6.2 INSTALLING THE CONNECTOR BASEPLATE * .....	7
6.3 INSTALLING THE PUMP .....	7
6.4 INSTALLING PUMP ELEMENTS .....	7
6.5 HYDRAULIC CONNECTIONS .....	8
6.6 INSTALLING THE OPTIONAL SMP OR SMPM DIVIDER VALVE.....	8
6.7 INSTALLING IP69K PROTECTION EQUIPMENT (OPTIONAL)*.....	9
6.8 ELECTRICAL CONNECTIONS & WIRING .....	9
6.8.1 Connector Types .....	10
6.8.2 Remote Control switch and Lamp .....	12
7. OPERATING INSTRUCTIONS .....	12
7.1 BEFORE PUTTING INTO OPERATION .....	12
7.2 OPERATION .....	12
7.3 SETTING OF ADJUSTABLE PUMPING UNIT .....	12
7.5.1 Operating mode: MANUAL VERSION.....	14
7.5.2 Operation mode – Automatic version Mode CYCLE.....	14
7.5.4 Operation mode – Automatic version Mode OFF .....	15
7.6 PROGRAMMING THE ELECTRICAL CONTROLLER .....	15
8. TROUBLESHOOTING.....	17
9. MAINTENANCE PROCEDURE .....	18
9.1 Programmed and operational Maintenance .....	18
10. DISPOSAL.....	18
11. ORDERING INFORMATION .....	19
12. DIMENSIONS.....	20
13. HANDLING AND TRANSPORTATION .....	21
14. OPERATING HAZARDS .....	21
14.1 Lubricants .....	21
15. PRECAUTIONS.....	22
Copyright .....	23

## 1. INTRODUCTION

This operation and maintenance manual refers to the **Bravo** lubrication pump, and includes essential information regarding correct operating and safety procedures design to ensure safe and reliable operation of the unit.

You can obtain the latest release of this document by contacting a Dropsa sales office or distributor or by visiting us on the World Wide Web at <http://www.dropsa.com>.

It is important that this document is read and maintained in a place that anyone operating the Bravo is able to consult it if necessary.

## 2. GENERAL DESCRIPTION

### 2.1 CENTRALIZED LUBRICATION – GENERAL OPERATING INFORMATION

Centralized lubrication systems are designed to provide oil or grease for lubricating friction points on industrial and mobile machinery. Such systems considerably reduce the cost of maintaining machinery on which they are installed, eliminating machinery downtime caused by poor lubrication as well as prolonging the life of the machinery in general. Additionally, a centralized lubrication system allows difficult to reach lubrication points to be lubricated at frequent intervals that would otherwise be hard to access under normal conditions.

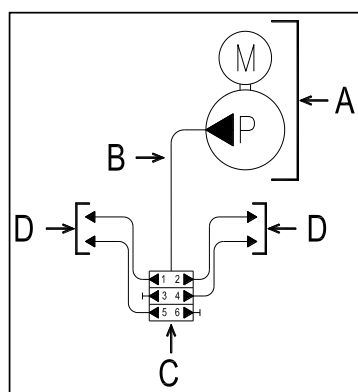

The diagram on the left shows a typical schematic of a simple centralized lubrication system.

The main components are:

**A – Electric Pump with Reservoir (eg. Bravo Pump).**

**B – Primary lubrication line for distributing grease.**

**C – Distributor elements that meters grease into a number of points.**

**D – Secondary tubing that delivers grease to the lube point.**

The pump feeds a distributor element that shares and doses the ratio of grease between the several friction points.

Bravo Pump has been designed to provide the pumping solution for such systems used in industrial and mobile applications for greases up to NLGI 2 consistency and Oils with minimum 46cSt.

### 2.2 BRAVO ELECTRIC GREASE PUMP

BRAVO is an electric piston pump with the pumping element operated from a camshaft connected to a reducing gearbox. It can be fitted with up to 3 pumping elements (1 standard) which are available with or without an integrate pre-set bypass (pressure safety valve).

The Bravo also has a modular build reservoir that can be supplied in 2, 5, 8 litre capacity. Additionally a minimum level sensing device is fitted as standard at the base of the unit. As an optional accessory, a remote button with light is available.

Bravo is available as both with an integrated automatic control board that controls and monitors the pump and lubrication cycle or a manual version where the pump motor is controller externally by applying and removing power.

The main body of the pump is made from high performance robust plastic and is compact in size designed to withstand tough environments.

The grease version of the Bravo includes a stirrer device with a reservoir wiper that help to eliminate air present in the grease and facilitate pumping even at lower temperatures.

The direct-current geared motor drive arrangement, is controlled remotely in the manual version or via the built in control system in the automatic version. There are three operating modes for the controller version. (Refer to 5.1 paragraph)

## 3. PRODUCT IDENTIFICATION

On the side of the pump there is a label that indicates part number of the product, operating voltage and basic characteristics.

#### 4. TECHNICAL CHARACTERISTICS

GENERAL TECHNICAL CHARACTERISTICS										
Operating Voltage	AC		DC		AC - 50Hz		AC - 60Hz			
	12V	24V	12V	24V	110V	230V	110V	230V		
Current (nominal)	1A	0,5A	1A	0,5A	0,2A	0,1A	0,2A	0,1A		
Current (peak)	6,5A	3A	6,5A	3A	0,3A	0,2A	0,3A	0,2A		
Nett weight	2 Liter	5,5Kg (12.12lb)				6,5 Kg (14.33lb)				
	5 Liter	6Kg (13.22lb)				7Kg (15.43lb)				
	8 Liter	6,5Kg (14.33lb)				7,5Kg (16.53lb)				
Number of outlets / pumping elements	1 (3 max.)									
Outlet thread	1/4" BSP									
Nominal output per pump element (20 RMP) *	2,8 cm <sup>3</sup> /min (0.17 in <sup>3</sup> /min) 5,2 cm <sup>3</sup> /min (0.31 in <sup>3</sup> /min) 0,4 ÷ 2,8 cm <sup>3</sup> /min (0.02 ÷ 0.17 in <sup>3</sup> /min) - Adjustable									
Working pressure	280bar (4061psi)									
Integrated By-pass pressure (if present)	320 bar ±30 bar (4641 psi ±435 psi)									
Reservoir Capacity	2 – 5 – 8 litres (0.53 – 1.32 – 2.11 gallons)									
Max Grease capability	NLGI 2									
Min. oil viscosity	46cSt									
Operating temperature	-25°C ÷ +80°C									
Storage temperature	-30°C ÷ +90°C									
Humidity	90%									
IP Protection grade	IP65 (IP 69K with special equipment)									
Noise	< 70 db (A)									
CONTROL PANEL CHARACTERISTICS										
Operating Voltage	12VDC ±20%									
	24VDC ±20%									
	110VAC	Includes internal transformer								
	230VAC									
Maximum Output load capability	5A									
Short circuit & Overload protection.	7.5A typical				10A max.					
Operating temperature	-20°C ÷ +80°C									
Storage temperature	-30°C ÷ +90°C									
Hardware protection	<ul style="list-style-type: none"> <li>• Overload protection on motor and lamp</li> <li>• Integrated Motor protection</li> <li>• Spike voltage protection</li> <li>• Inverted Polarity protection</li> </ul>									
Memory for parameter storage	EEPROM									
Memory Life	Unlimited (no battery requirement)									
Minimum Level										
Max load	AUTOMATIC Version				1A	@	30V			
					0,3A	@	230V			
	MANUAL Version				0,25A	@	120V			
ELECTRICAL CONNECTIONS										
P/N Connector	Nominal Voltage	Poles	Max Cable.	IP	Max. A					
0039975 (MPM 203)	250V-300V	3+ $\frac{1}{2}$	1mm <sup>2</sup>	65	10A					
0039820 (M12)	150V	4	0,5mm <sup>2</sup>	68	4A					
0039823 (Amphenol)	1680V	17+PE	1mm <sup>2</sup>	65	6A					
0038962 (IP69K)	600V	3	0,5mm <sup>2</sup>	69K	7,5A					
0039834 (IP69K)	600V	4	0,5mm <sup>2</sup>	69K	7,5A					



\* NOTE: Pump output has been determined at the following conditions: Grease, NLGI 2, Standard environmental conditions (Temperature 20°C / 68°F, Pressure 1 ATM), Back pressure on outlet 50bar (735 psi) 12V e 24V voltage.



**WARNING:** Do not operate the unit outside the specified voltage ranges.

## 5. PUMP COMPONENTS

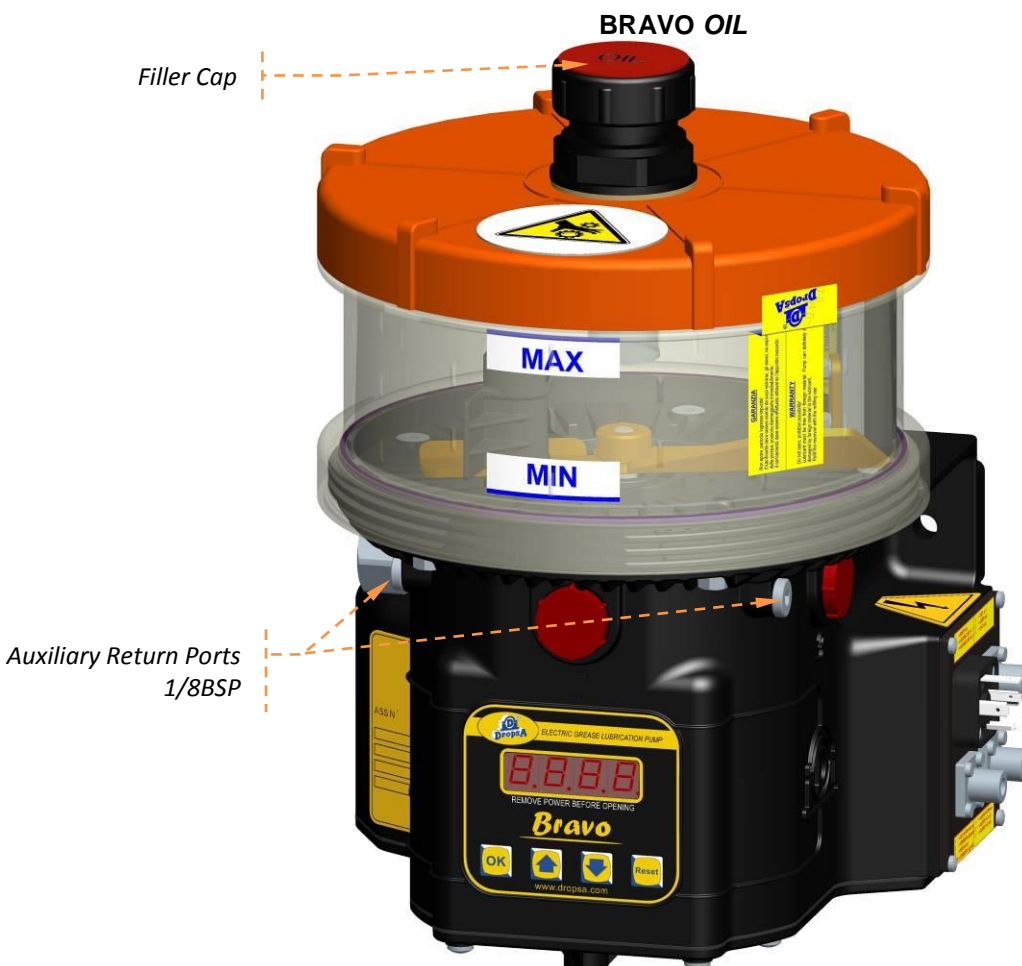
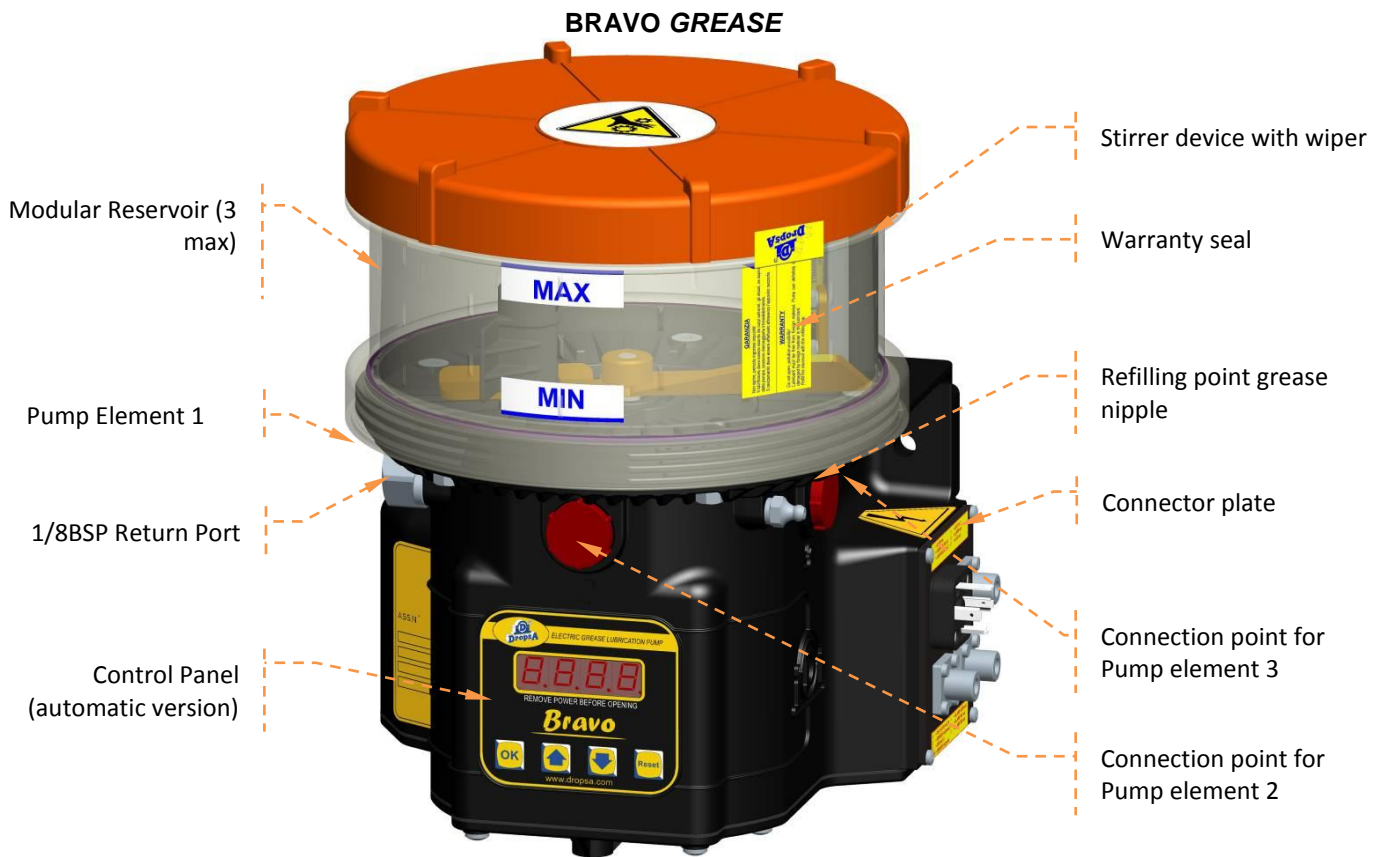

## 5.1 PUMPING UNITS IDENTIFICATION

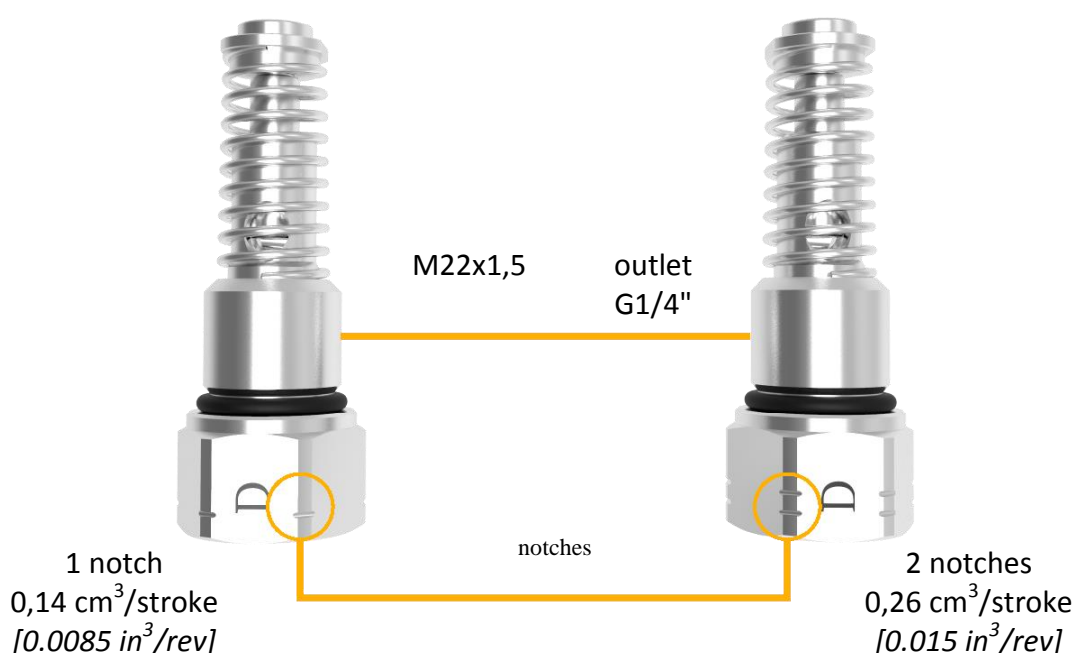

\*For use of the 5,2cc pumping unit contact Dropsa for assembly instructions and recommended versions.

\*For use of nr.2 5,2cc pumping units, the assembly must be at 180° in the respective locations.

\*It is possible to use a maximum of 2 5,22cc pumping units.

### 5.1.1 ELECTRONIC CONTROL BOARD.

In the automatic version, pump and cycle control is managed by the onboard controller. Three operating modes are possible:

1. **CYCLE:**      **Lube and pause cycles are set** using the built in timer or counting external inputs; the two condition work with every combinations
2. **PULSE**      Lube Cycle and Pause cycle are determined by external inputs. During of Lube Cycle, the cycle sensor can be monitored to ensure a correct system working. Pump can suspend the lube cycle if external pulses are not found.
3. **OFF:**          Pump works as slave regarding the control of the machine

BRAVO pump has a multi connection system that allows to apply various standards types of connectors to the product to satisfy OEM and end users requests.

Pump has been designed in order to integrate quickly SMP and SMPM metering elements.

Programming instructions can be found in chapter 7 of this manual.

## 5.2 MINIMUM LEVEL

In manual version (no control board) the minimum level switch (Normally closed) opens when the minimum level is reached. With the automatic (controlled) version, a voltage free changeover contact NC/NA can be obtained to give a remote signal of minimum level.

## 5.3 CONNECTIONS & WIRING

Different connectors and wiring are available as standard by fitting a selection of connector plates. It is also possible for custom settings for OEM clients.



## 6. UNPACKING AND INSTALLING

### 6.1 UNPACKING

Once a suitable installation position has been identified, unpack the pump and prepare for installation. It is important to inspect the pump to ensure that there has been no damage during transportation. The packaging material used does not require any special disposal procedures. You should refer to your regional requirements.

### 6.2 INSTALLING THE CONNECTOR BASEPLATE \*

The pump and the base plate are purchased separately. To install the base plate following the following steps:

- Connect the multi pin connector from the base plate until security locking (fig.1).
- Fit the base plate into position as shown in figure 2 and use the 4 screws to lock into position (fig.2)



fig. 1

fig. 2

\* **Note:** 110/230V versions have two multi pin connectors inside

### 6.3 INSTALLING THE PUMP

- On the bottom of the box there is a mounting hole template as shown in the diagram on the right. This can be used to drill the fixing holes. The fixing holes should be  $\varnothing 9\text{mm}$  ( $\varnothing 0.35$  inch). Use 3 screws to fix the pump into place.
- Assemble the pump so that the filling point and the control panel are accessible by the user.
- Allow 100mm (4 inches) perimeter distance around the pump for easy access.
- Ideally, install the pump at a height that is easily and comfortably accessible by the user to facilitate maintenance and refilling.
- Do not install the pump where it may be submerged by liquids or in an excessively aggressive environment.
- Do not install the pump in hazardous areas where there may be flammable or explosive materials.
- Do not install near strong heat sources or electrical areas that may cause electrical interference with the control system.
- Ensure that tubing and wiring is appropriately secured and protected.

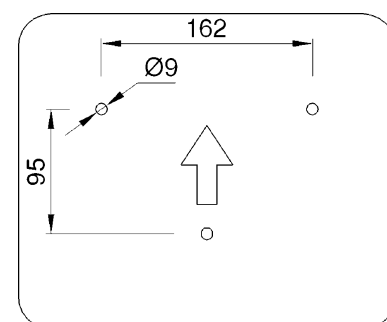

### 6.4 INSTALLING PUMP ELEMENTS

Bravo pump is supplied with a single pumping element with by-pass ( $2,8 \text{ cm}^3/\text{min}$ ) installed in Port 1. The additional pump elements can be installed in any of the additional pump port (2 or 3). It is also possible to move Pump Element 1 to another port if necessary, for example to simplify piping arrangements on the lubrication system. To install a new pump element:

- Unscrew and remove the plastic plug with the O Ring that is installed on the standard product.
- Insert and screw the pump element until it is fixed in position.
- Use 20Nm torque to secure the element.



**WARNING:** Based on the position of the internal cam drive it may be difficult to screw in the pump element a sit compresses the return spring. In this case, use another outlet or of pay particular attention when inserting the pump element and ensure that it does not cross-thread.

## 6.5 HYDRAULIC CONNECTIONS

The hydraulic connection to the pump is via the pump outlets using adequate 1/4BSP fitting and tubing. Additionally there is a 1/8" BSP port that can be used as a return line or a remote refilling line. Ensure that any refilling system provides clean grease to the pump.

## 6.6 INSTALLING THE OPTIONAL SMP OR SMPM DIVIDER VALVE

On the base of the pump it is possible to install an SMP or SMPM distributor valve to further divide the lubricant. This should be secured using fixing screws. Refer to the diagram below:

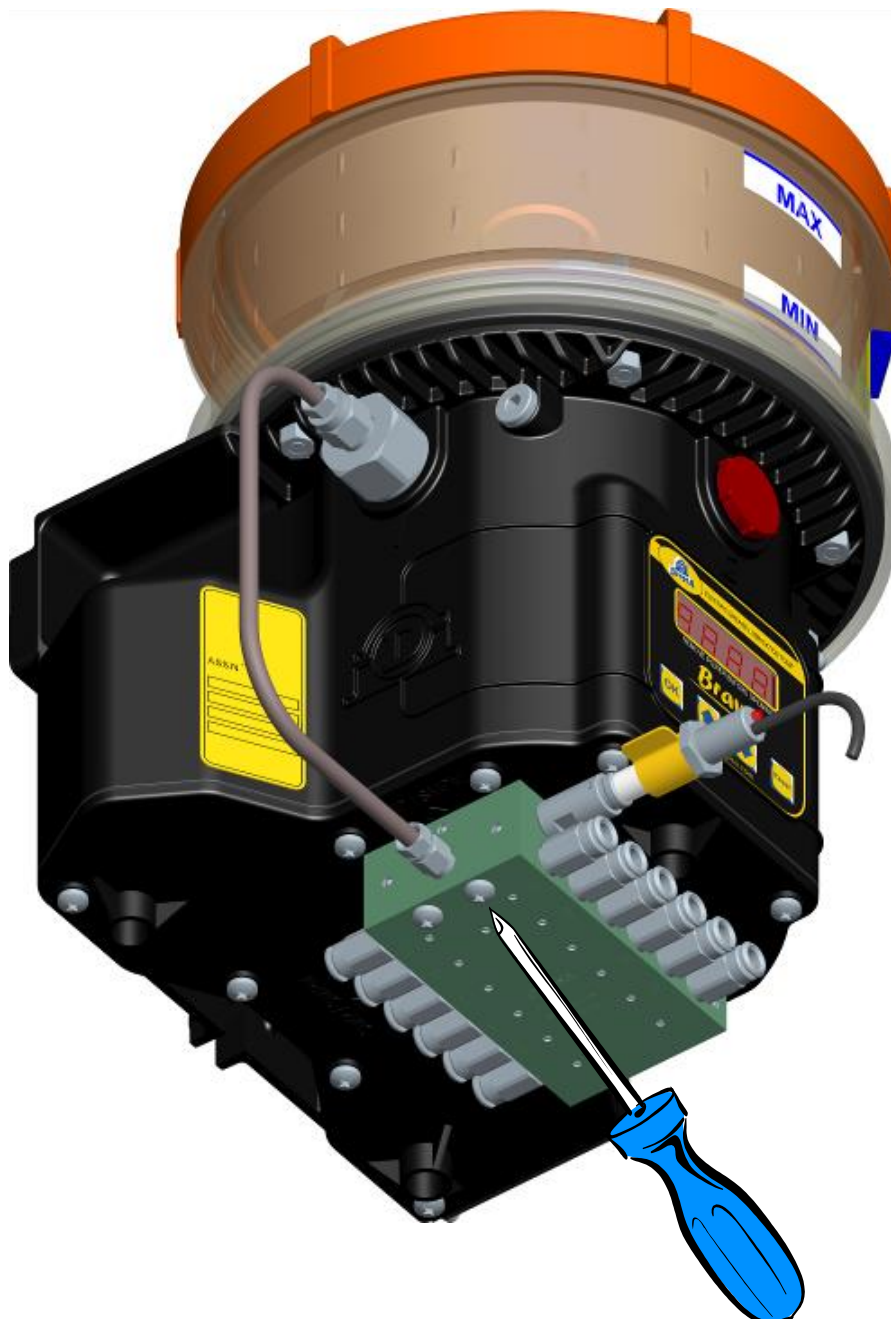



## 6.7 INSTALLING IP69K PROTECTION EQUIPMENT (OPTIONAL)\*.

Bravo pump can be configured with an IP 69K protection degree according to DIN 40050.

To do this is necessary install the right connector plate as mentioned at paragraph 6.2. In addition the key board protection cover has to be mounted.

For cover assembling proceed according to the following steps:

- Remove the four plugs on the pump body using a screwdriver avoiding the sealing rim damage;
- Fit the silicon membrane into the square frame seat;
- Fit the four screws into the holes assembling the membrane;
- Fit the complete frame avoiding a membrane movement;
- Screw the four screws.

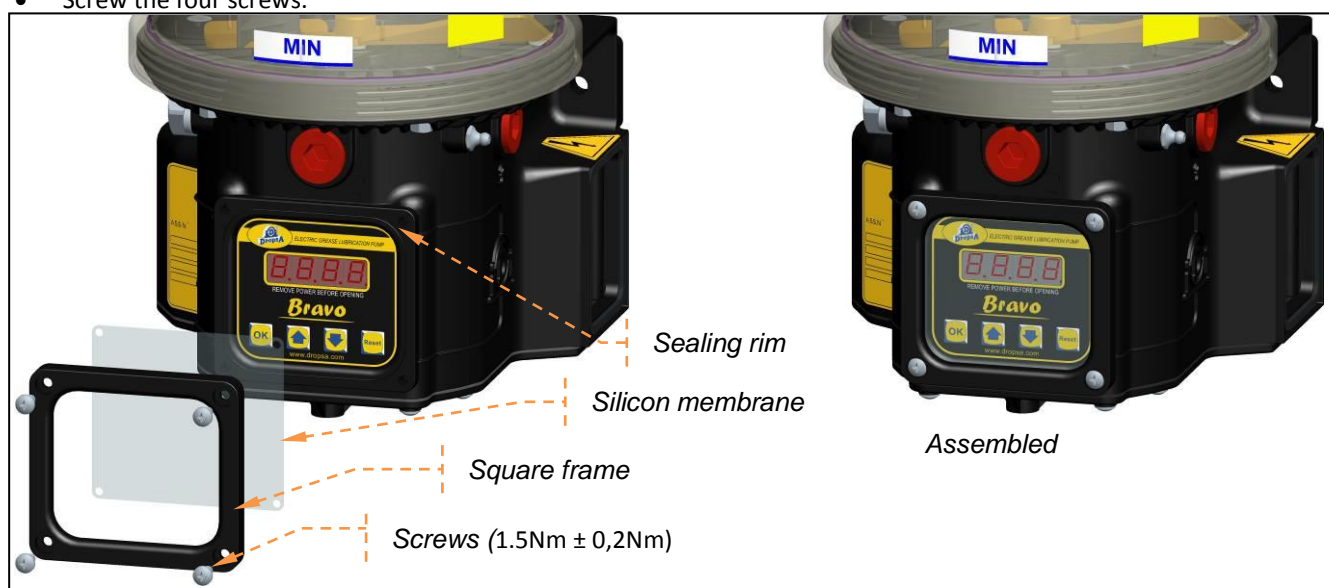

\***Note:** IP69K kit can be installed on pumps manufactured with a WO following 1207322.

## 6.8 ELECTRICAL CONNECTIONS & WIRING



**CAUTION:** Before carrying out any electrical wiring you should verify the label on the pump to ensure that the correct operating voltage is being used and ensure that all power is removed.

The electrical connection should be carried out an electrician who has understood and identified the various connectors and wiring that has been selected for the system (operating voltage, connector types, remote control, cycle sensors).

Connect the pump to the power supply using the appropriate power connector (refer to 6.7.1 *Connector types*) again ensuring they are suitable for the selected voltage and frequency. The power cable should be adequately chosen to ensure it can handle the current at the specified voltage.

On 110V/230VAC versions it is strongly recommended that a 1A fuse T and a differential trip is installed with an activation level of 30 mA at 1 millisecond max. Isolation capability should be = 10kV minimum and nominal current  $\geq 4$ Amps.

## 6.8.1 Connector Types

### VERSIONS 12V/24V

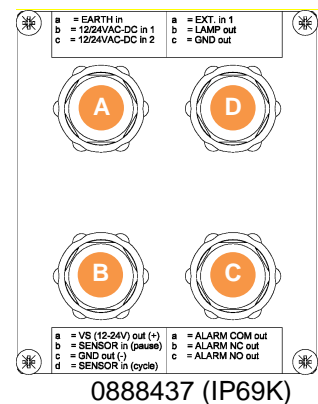
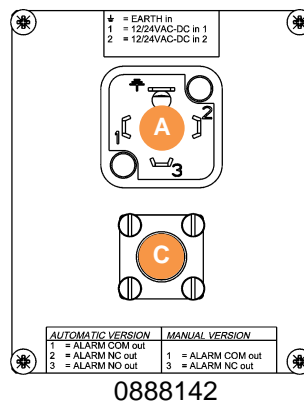
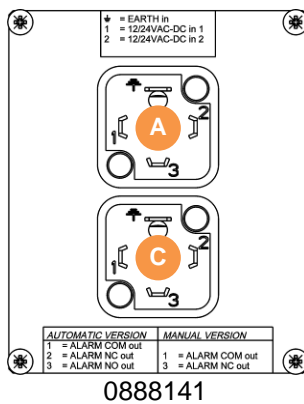
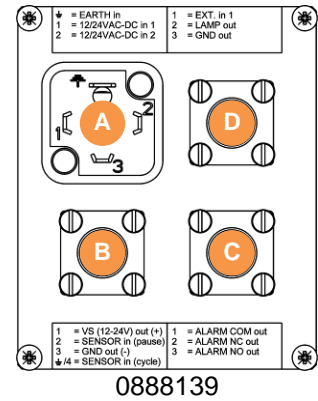
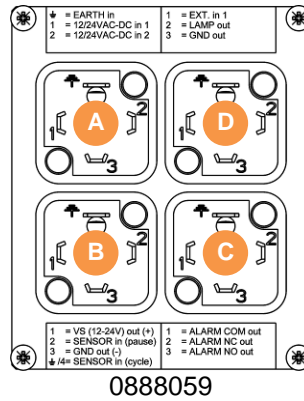
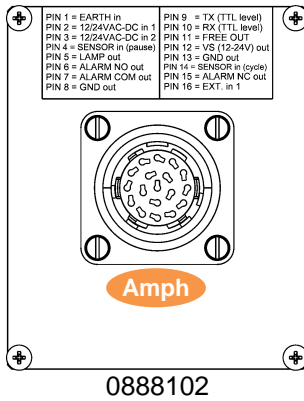

### VERSIONS 110V/230V -50Hz/60Hz

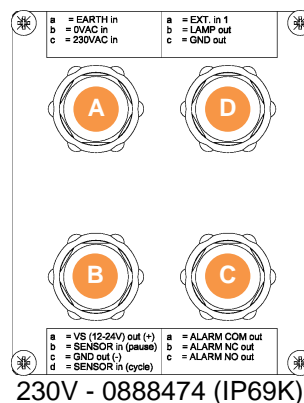
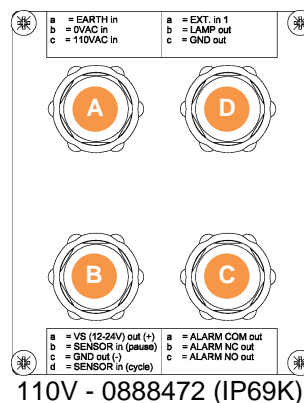
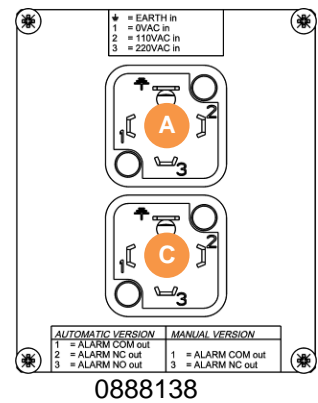
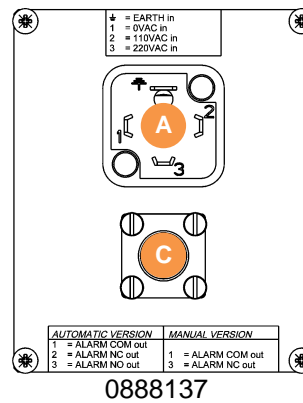
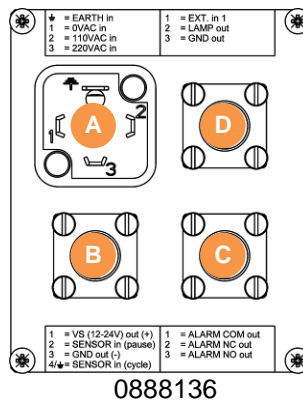
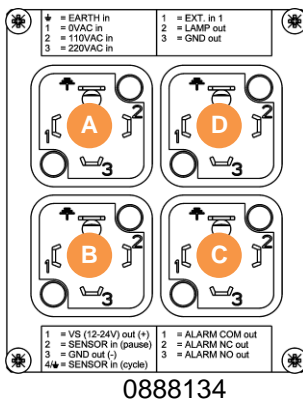

Wiring **Amph** MULTIPOLE Connector

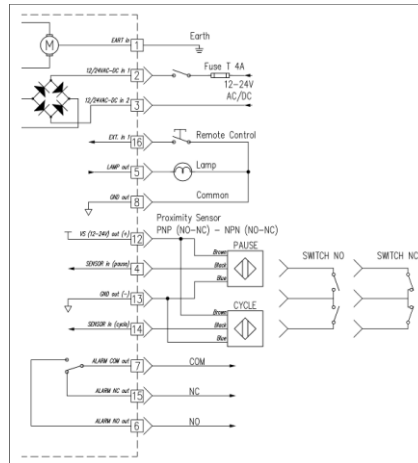

Wiring **A** POWER SUPPLY

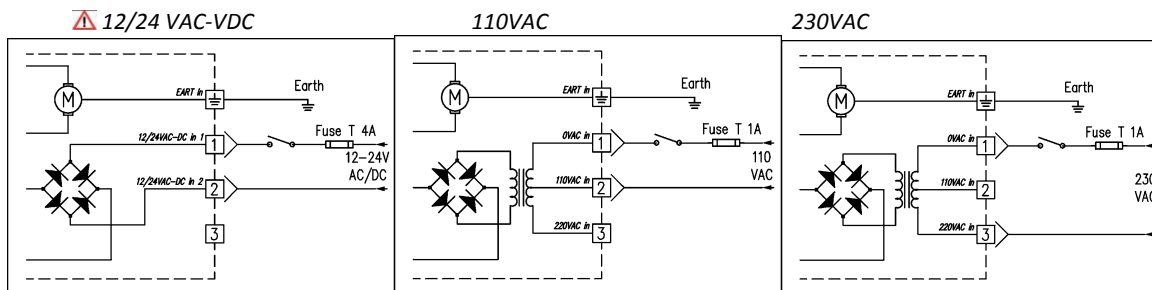

**⚠** On 12/24 VAC-VDC manual version do not connect earth terminal

Wiring **B** CYCLE SENSOR

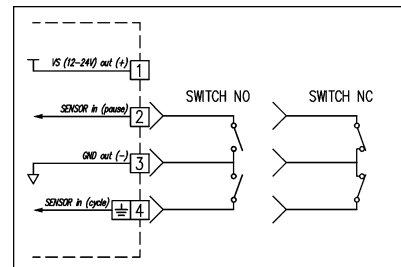
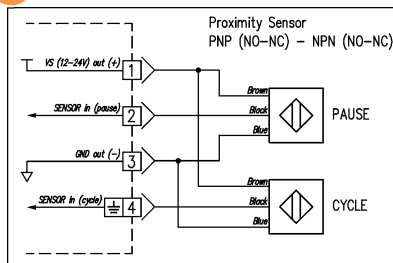

Wiring **C** MINIMUM LEVEL

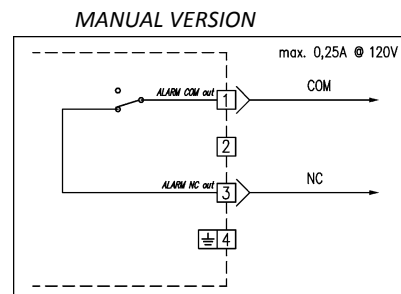
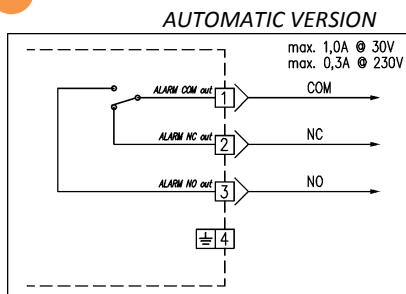

Wiring **D** REMOTE CONTROL

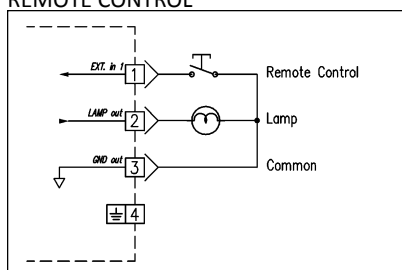

## 6.8.2 Remote Control switch and Lamp

After connecting the pump, it is possible to continue the installation by connecting the remote switch/lamp when in systems where this has been installed.

Install the remote switch by the control panel of the vehicle or machine.  
Refer to the following diagram to connect the switch and lamp.

POWER	LAMP	OPTIONAL
230Vac	12Vdc (3A max)	0039433
110Vac	12Vdc (3A max)	0039433
24Vac/dc	24Vdc (3A max)	0039434
12Vac/dc	12Vdc (3A max)	0039433

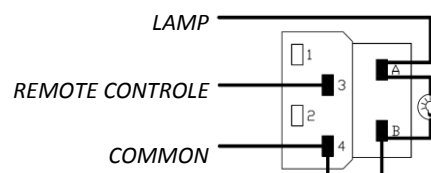

## 7. OPERATING INSTRUCTIONS

### 7.1 BEFORE PUTTING INTO OPERATION

- Note that the unit should not be dismantled by the user if a fault is found.
- Use gloves when handling lubricants and ensure you have checked the lubricant safety data sheet.
- Do not use lubricants that are incompatible with NBR (Buna) seals.
- Ensure that you have complied with all health and safety requirements before putting the pump into service.
- Maintain proper hygiene standards. Never ignore any potential danger to health.
- Ensure all tubing and fittings are designed to handle the maximum system pressure.
- Check integrity in the pump. Ensure no damage;
- Check and fill the reservoir. If the reservoir is below the MIN level, follow procedure 7.4 to refill;
- Verify the pump is at the correct operating temperature and tubing is free of air bubbles;
- Check the unit is properly cabled.

### 7.2 OPERATION

- Check and set the operating mode and parameter if using the automatic versions.
- Press the remote start button on your machine if using a manual version.
- Check that the pump is running.
- Check lubricant is being delivered to the greasing points as necessary.

### 7.3 SETTING OF ADJUSTABLE PUMPING UNIT

To set the progressive pumping unit with adjustable flow, proceed as follows:

- Ensure there is no residual pressure in the pressure line.
- Remove the adjustment access cap using a 4mm Allen wrench
- Rotate the jacket of the pumping unit using a 4 mm Allen wrench inserted in the internal grub screw.
- Each complete rotation of the Allen wrench is approximately 0.6cc/min. Setting range from 0.4 to 2.8 cc/min. for a total of 4 rotations.
- Check the presence and conformity of the copper gasket (replace if necessary).
- Replace the cap using a 4 mm Allen wrench.

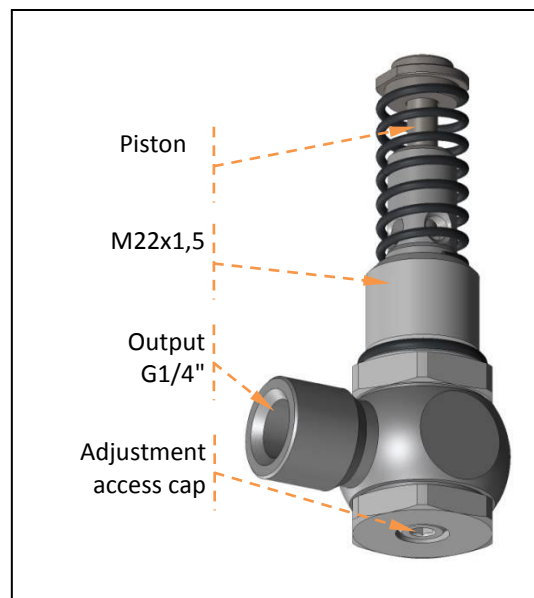

## 7.4 REFILLING THE RESERVOIR

The refilling of the tank is carried out through the dedicated filling ports with adequate filtration to ensure clean lubricant. Continue to fill unit until the max level is reached/ this level should not be exceed. In the event the user overfills the tank, the excess lubricant will be expelled through vent holes located under the lid.

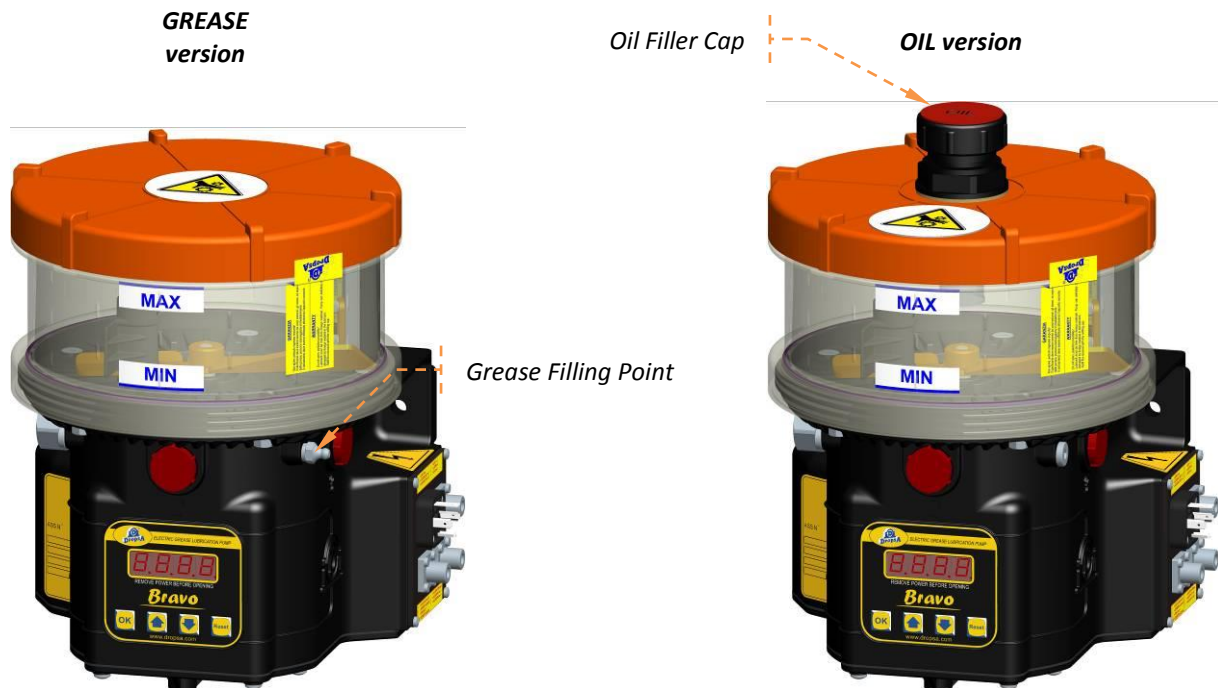

**WARNING:** to avoid introducing contamination into the pump and voiding the warranty ensure that refilling is always carried out through the designated ports using clean grease. Refer to 14.2 for more information about lubricant characteristics.

## 7.5 CONFIGURATION

Automatic version  
Control panel layout



Optional Remote Light Button



The light is constantly lit when the pump is running. Flashes when a minimum level or other alarm is detected by the control system in the pump. The number of flashes defines the anomaly code. When pressed during the pause (standby) cycle, it will make the pump starts a lubrication cycle and then return to normal automatic operation. The RESET of the pump is allowed when the button is pressed for 6 seconds.

### 7.5.1 Operating mode: MANUAL VERSION

The Bravo Manual version does not have any settable feature as there is no local controller. You should arrange to control the pump ON/OFF with a host system that activates the pump as required and monitors the lubrication system, including checking level switch and cycle switch when installed.

### 7.5.2 Operation mode – Automatic version Mode CYCLE

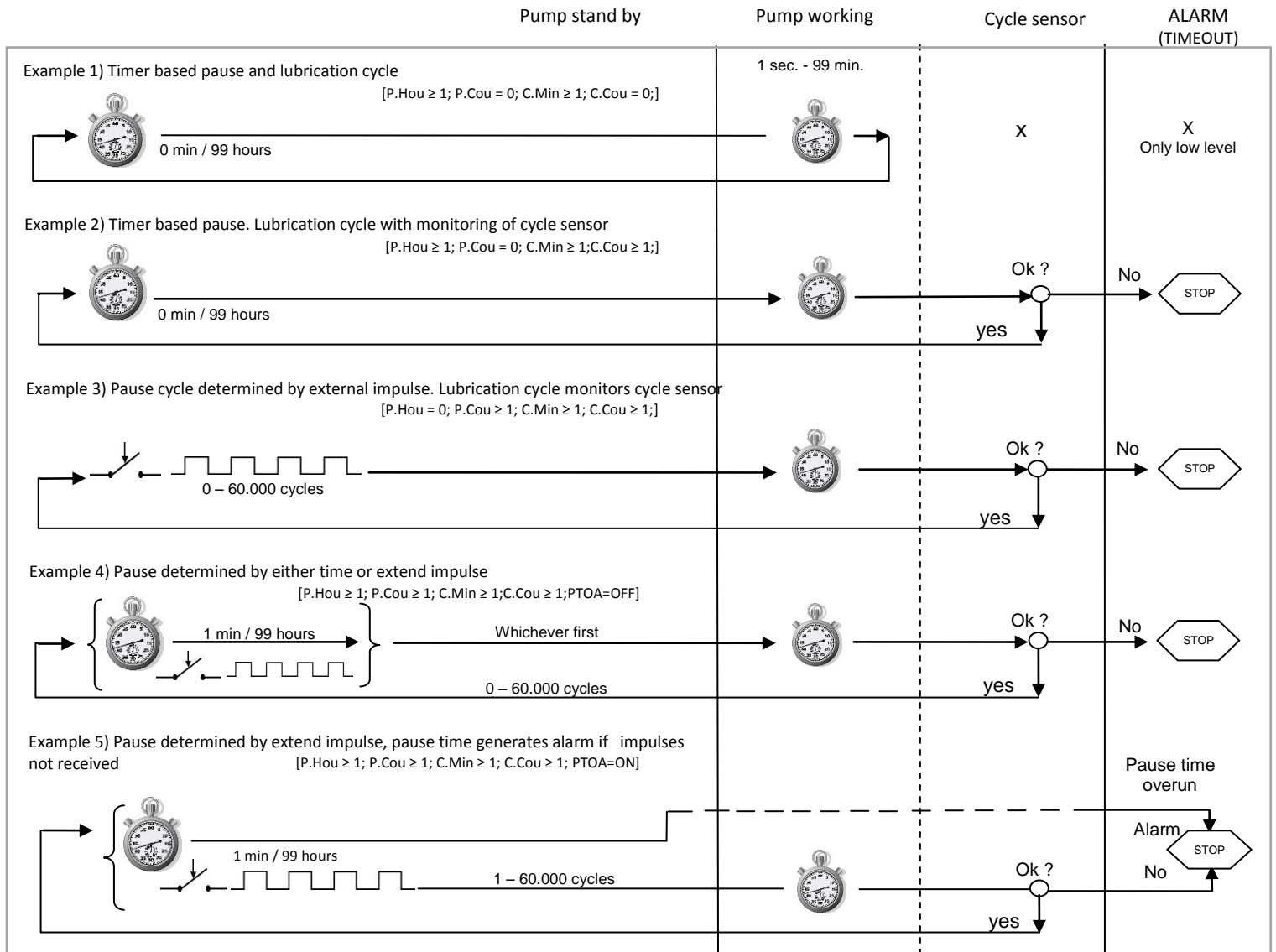

### 7.5.3 Operation mode – Automatic version Mode PULSE

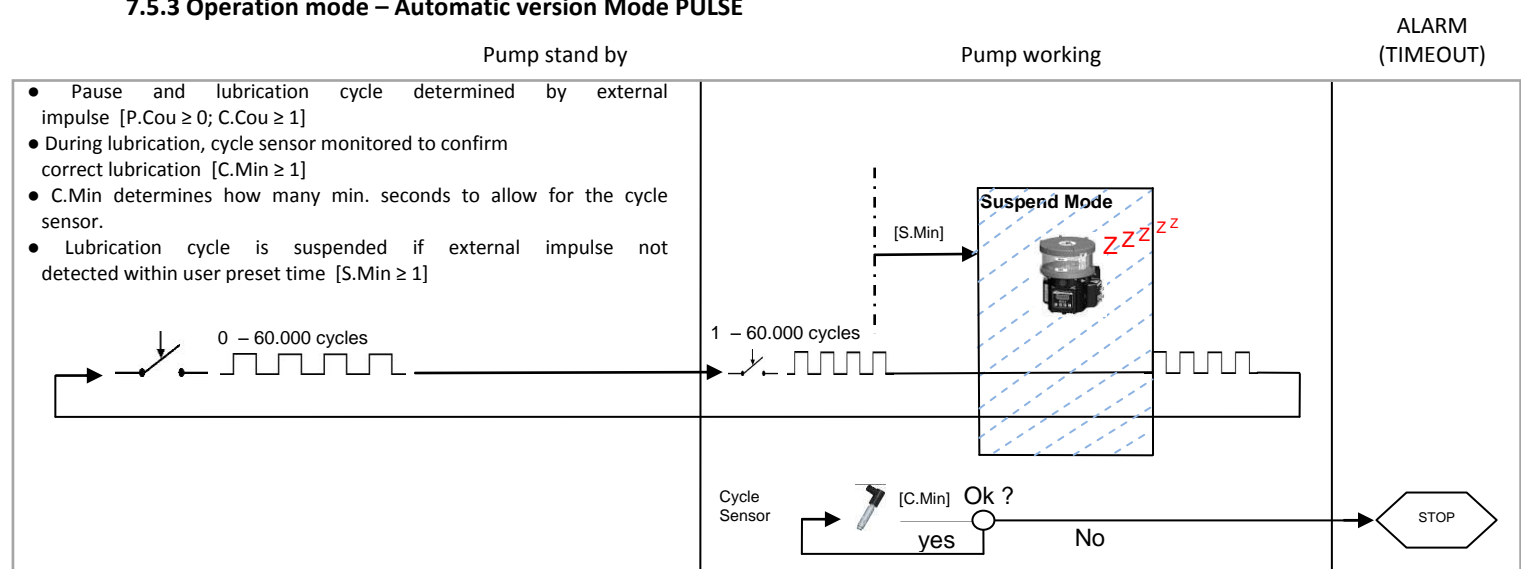



## 7.5.4 Operation mode – Automatic version Mode OFF

Pump operates when external signal is given. No monitoring



**NOTE:**









When power is removed from the Bravo, the electronic control will save the cycle condition in memory. When power is reapplied the controller will resume the logic from exactly the same point (unless the PRELUBE option is set).

When powering on the system or when pressing the RESET button the display will the firmware version of the unit for 2 seconds.

For all modes the Prelube parameter determines if the pump starts in a lubrication cycle when it is set to ON.

Cycle and Pause inputs consider one complete cycle when the input returns to its original state at the time of cycle. For example, if the switch is in the ON state at the start of the lubrication cycle then it must change state to OFF, and then back to ON to count as one cycle.













## 7.6 PROGRAMMING THE ELECTRICAL CONTROLLER



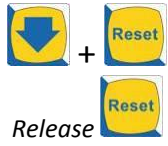



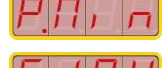





PROGRAMMING SEQUENCE		
STEP	BUTTONS	OPERATION
1	 hold for 5 seconds.	Enter programming mode
2	 or 	Select PARAMETER to change
3		Confirm the selection and view the current value
4	 or 	Increment/Decrement VALUE/SETTING of PARAMETER
5		Confirm value/setting and return to menu
6	 hold for 2.5 seconds.	Save settings and exit programming mode

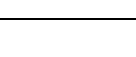

**NOTE:** To modify the operating parameters repeats steps 2 to 5 for all necessary values and then follow step 6 to save and exit.

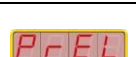
During programming mode, if no button is pressed for 20 seconds, or alternatively UP or DOWN arrows are held for 2.5 seconds, this will exit Programming mode without saving the values.

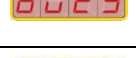
SPECIAL FUNCTIONS AND PARAMETERS		
BUTTONS	DISPLAY	DESCRIPTION
		Lock key board. Reset is operating
		Unlock keyboard
 Release		Reset the default values in the active operating mode
 Release		Display total days in working state
		Display total minutes in working state
		Display total days in pause state
		Display total minutes in pause state
		Display total days in alarm state
		Display total minutes in alarm state





DISPLAY	DESCRIPTION	PARAMETRI OPERATIVI			
		MODE	DEFAULT	RANGE	NOTES
		CYCLE PULSE OFF			Cycle 100%
	PAUSE TIMER: SET Hours and Minutes	CYCLE	10 min	0 min / 99 ore	Both
	TIMER to suspend the cycle	PULSE	0 sec	0 sec / 99 min	
	PAUSE COUNTER: number of divider switch cycles to wait in pause	CYCLE PULSE	1 cycle	0 / 60000	Complete Cycle
	CYCLE TIMER: if timed cycle it indicates the duration; if cycle with control impulses, indicates the waited maximum time of the single impulse before alarm	CYCLE PULSE	1 min	99 min / 1 sec	
	CYCLE COUNTER: number of divider switch cycles per lubrication cycle. input used: ▪ Sensor Cycle if Cycle Mode ▪ Sensor Pause if Pulse Mode	CYCLE PULSE	1 ciclo	0 / 60000	Complete Cycle
	PRELUBE: Start –controller in Lubrication mode when powered on.	CYCLE PULSE	OFF	ON-OFF	
	Motor DUTY: allows reduction in pump output by adjusting motor speed	CYCLE PULSE OFF	100	100 / 50	
	Number of cycles given from the manual input ( it allows eventual filling system)	CYCLE PULSE	1	0 / 9999	
	If OFF, to expiring of the pause time, stars the lubrication cycle If ON, to expiring of the pause time, gives Pause Time Overrun alarm.	CYCLE	OFF	ON-OFF	
	If OFF, the minimum level is excluded.	CYCLE PULSE OFF	ON	ON-OFF	









**NOTE: Continuous Cycle:** Continuous cycle can be achieved by setting the pause timer to zero.  
**Complete cycle:** Valid on input full cycle ON>OFF>ON or OFF>ON>OFF. **Both:** When the pause timer is set to non zero, the system operates in a combined mode. The cycle will start EITHER on impulse Count OR Pause Time being reached.

## 8. TROUBLESHOOTING

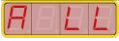
Below is a trouble shooting table to show possible problems and solutions. If you are in any doubt about the correct solution to fixing a problem, do not dismantle parts of the Bravo but contact an Authorized Dropsa Sales and Service Point for technical assistance.

<b>TROUBLESHOOTING TABLE</b>		
<b>PROBLEM</b>	<b>POSSIBLE CAUSE</b>	<b>REMEDIAL ACTION</b>
Pump Motor does not operate	Power missing.	Check the power lines, ensure that any fuse installed is still intact.
	Electronic Controller does not function.	Replace electronics board. 
	Gear motor no longer works.	Replace gear motor assembly. 
Pump is operating but no lubricant reaches points	Tubing is disconnected.	Check the condition of tubing in the system and ensure that it is correctly secured and not blocked for example, by hardened grease.
	Distributor valves are blocked.	Clean or replace.
	Presence of air in the lower casing of the pump	Detach the fitting of the pump, start the pump until the grease starts coming out; reattach the fitting and verify that the pump distributes properly.
	Pump blocked	Disassembly and cleaning the pump;  or replace the pump.
	Progressive distributor blocked	Unblock the progressive distributor by means of removing the cap corresponding to the piston and shift the position of the piston; re-tighten the cap and verify that the pump distributes properly. In case the defect persists, replace the progressive distributor.
Lubricant does not reach lubrication points on each pump cycle or irregularly	Distributor valves are incorrectly connected or sized.	Check valves and system schematic.
	Incorrect Pause/Cycle Settings.	Ensure that the system designs and settings allow for at least a full cycle for all distributor valves in the system.
<b>PROBLEM</b>	<b>POSSIBLE CAUSE</b>	<b>REMEDIAL ACTION</b>
No lubricant from pump	Reservoir is empty.	Refill, and verify any low level alarms.
	Air bubble in grease	Disconnect the primary tubing from the pump and operate a lubrication cycle. Check that clean, air free grease is coming from the pump and then reconnect the tubing.
	Incompatible lubricant.	Some lubricants are not suitable for automatic pumping systems. Replace the grease.
	Blocked pumping element.	Dismantle the pumping element and check for contamination. Clean and reinstall or replace.
	Worn pump element.	Replace pump element.
	Pump element Check worn.	Replace pump element.
The display is not lit	Incorrect power/voltage.	Check power and voltage. Ensure proper power supply to pump.
The pump starts the lubrication cycle but then immediately stops	Defective or blocked Pump motor.	Allow the pump to cool. Retry the lubrication cycle. If the problem persists it will be necessary to replace the pump motor assembly. 

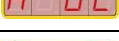
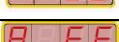
 : Allowed only specialized Dropsa's staff

ALARM CODES			
MESSAGE	LIGHT BUTTON	ALARM	REMEDY
	1 Flash	Low lubricant level in reservoir	Refill with clean lubricant.
	2 Flashes	Cycle Sensor overrun	The cycle sensor was not received within the specified time. Ensure Timer overlong is set to appropriate value and that there is no problem on the lubrication circuit.
	3 Flashes	Pause timer overrun	Verify input pause sensor
	4 Flashes	Pump Motor Blocked	Replace the motor unit
	5 Flashes	Pump Motor Over-load	Allow system to cool, if the problem still goes on go on, replace the motor unit.
	6 Flashes	C.COU pulses counter in Pulse Mode	Modify C.COU parameter
	7 Flashes	Eprom Error	Electronic Board memory error. Board requires replacement.

 **NOTE:** To cancel alarm message push buttons  and  together

## 9. MAINTENANCE PROCEDURE

 **WARNING:** Before carrying out any maintenance operation, ensure that power and hydraulic system are disconnected.

The Bravo pump does not necessitate any special tool for operation and maintenance. When working with the Bravo pump it is nonetheless recommended that personal health and safety equipment is used as is normal for any operation in an industrial or similar workplace to best safeguard the user from harm.

The Bravo pump has been designed and built as to require minimal maintenance and operate in diverse and challenging operating environment. It is recommend that the unit is inspected and kept clean to ensure long life and trouble free operation. It is important to check all tubing on the system to ensure that it is always tight and leak free.

### 9.1 Programmed and operational Maintenance

The following operations should be performed on the pump.

ITEM	FREQUENCY	OPERATION
Integrity of tubing and system	After initial 500 hours. Every 1500 hours.	Check fittings and tubing secured. Verify components are correctly fixed to machine.
Reservoir level	As needed.	Top up level with clean lubricant.
Filling Filter	As needed, or once per year.	Check and replace as necessary.

## 10. DISPOSAL

During maintenance or disposal of the machine care should be taken to properly dispose of environmentally sensitive items such as oils or other lubricants. Refer to local regulations in force in your area. When disposing of this unit, it is important to ensure that the identification label and all the other relative documents are also destroyed.

 **NOTE:** To cancel an error message press  and .

## 11. ORDERING INFORMATION

AUTOMATIC VERSION							
Operating voltage	GREASE			OIL			
	Reservoir 2Lt. (0.53gal)	Reservoir 5Lt. (1.32gal)	Reservoir 8Lt. (2.11gal)	Reservoir 2Lt. (0.53gal)	Reservoir 5Lt. (1.32gal)	Reservoir 8Lt. (2.11gal)	
110V/230V	0888400	0888401	0888402	0888415	0888416	0888417	
12V/24V	0888403	0888404	0888405	0888418	0888419	0888420	
MANUAL VERSION							
TENSIONE di alimentazione	GREASE			OIL			
	Reservoir 2Lt. (0.53gal)	Reservoir 5Lt. (1.32gal)	Reservoir 8Lt. (2.11gal)	Reservoir 2Lt. (0.53gal)	Reservoir 5Lt. (1.32gal)	Reservoir 8Lt. (2.11gal)	
110V/230V	0888406	0888407	0888408	0888421	0888422	0888423	
12V	0888409	0888410	0888411	0888424	0888425	0888426	
24V	0888412	0888413	0888414	0888427	0888428	0888429	
AUTOMATIC VERSION 12V/24V							
CONNECTION		FEMALE CONNECTOR		CONNECTIONS AVAILABLE			
CODE	DESCRIPTION	CODE	DESCRIPTION	Power	Alarm contact	Cycle sensor	External switch
0888102	Connector "Amph"	0039828	Connector "Amph"	•	•	•	•
0888059	4 connector "MPM"	0039976	Connector "MPM"	•	•	•	•
0888141	2 connector "MPM"	0039976	Connector "MPM"	•	•		
0888139	1 connector "MPM" 3 connector "M12"	0039976 0039999	Connector "MPM" Connector "M12"	•	•	•	•
0888142	1 connector "MPM" 1 connector "M12"	0039976 0039999	Connector "MPM" Connector "M12"	•	•		
0888437	IP69K – 12V/24V	0038963 0039835	Connector 3 pin IP69K Connector 4 pin IP69K	•	•	•	•
AUTOMATIC VERSION 110V/230V							
CONNECTION		FEMALE CONNECTOR		CONNECTIONS AVAILABLE			
CODE	DESCRIPTION	CODE	DESCRIPTION	Power	Alarm contact	Cycle sensor	External switch
0888134	4 connector "MPM"	0039976	Connector "MPM"	•	•	•	•
0888138	2 connector "MPM"	0039976	Connector "MPM"	•	•		
0888136	1 connector "MPM" 3 connector "M12"	0039976 0039999	Connector "MPM" Connector "M12"	•	•	•	•
0888137	1 connector "MPM" 1 connector "M12"	0039976 0039999	Connector "MPM" Connector "M12"	•	•		
0888472	IP69K – 110V	0038963 0039835	Connector 3 pin IP69K Connector 4 pin IP69K	•	•	•	•
0888474	IP69K – 230V	0038963 0039835	Connector 3 pin IP69K Connector 4 pin IP69K	•	•	•	•
MANUAL VERSION 12V/24V							
CONNECTION		FEMALE CONNECTOR		CONNECTIONS AVAILABLE			
CODE	DESCRIPTION	CODE	DESCRIPTION	Power	Alarm contact	Cycle sensor	External switch
0888141	2 connector "MPM"	0039976	Connector "MPM"	•	•		
0888142	1 connector "MPM" 1 connector "M12"	0039976 0039999	Connector "MPM" Connector "M12"	•	•		
MANUAL VERSION 110V/230V							
CONNECTION		FEMALE CONNECTOR		CONNECTIONS AVAILABLE			
CODE	DESCRIPTION	CODE	DESCRIPTION	Power	Alarm contact	Cycle sensor	External switch
0888138	2 connector "MPM"	0039976	Connector "MPM"	•	•		
0888137	1 connector "MPM" 1 connector "M12"	0039976 0039999	Connector "MPM" Connector "M12"	•	•		
OPTIONAL							
CODE	DESCRIPTION	CODE	DESCRIPTION				
0039433	Remote control switch and lamp 12V	0888058C	2,8cm <sup>3</sup> /min pumping element <b>with</b> by-pass 1 notch				
0039434	Remote control switch and lamp 24V	0888156	2,8 cm <sup>3</sup> /min pumping element <b>without</b> integrated by-pass 1 notch				
0888038	Grease cartridge kit	0888391	5,2 cm <sup>3</sup> /min pumping element 2 notches				
0038966	IP69K protection plug connector	0888555	0,4÷2,8 cm <sup>3</sup> /min adjustable pumping element				
0888470	IP69K protection kit	0010509	Screw for SMP-SMPM assembling				

## 12. DIMENSIONS

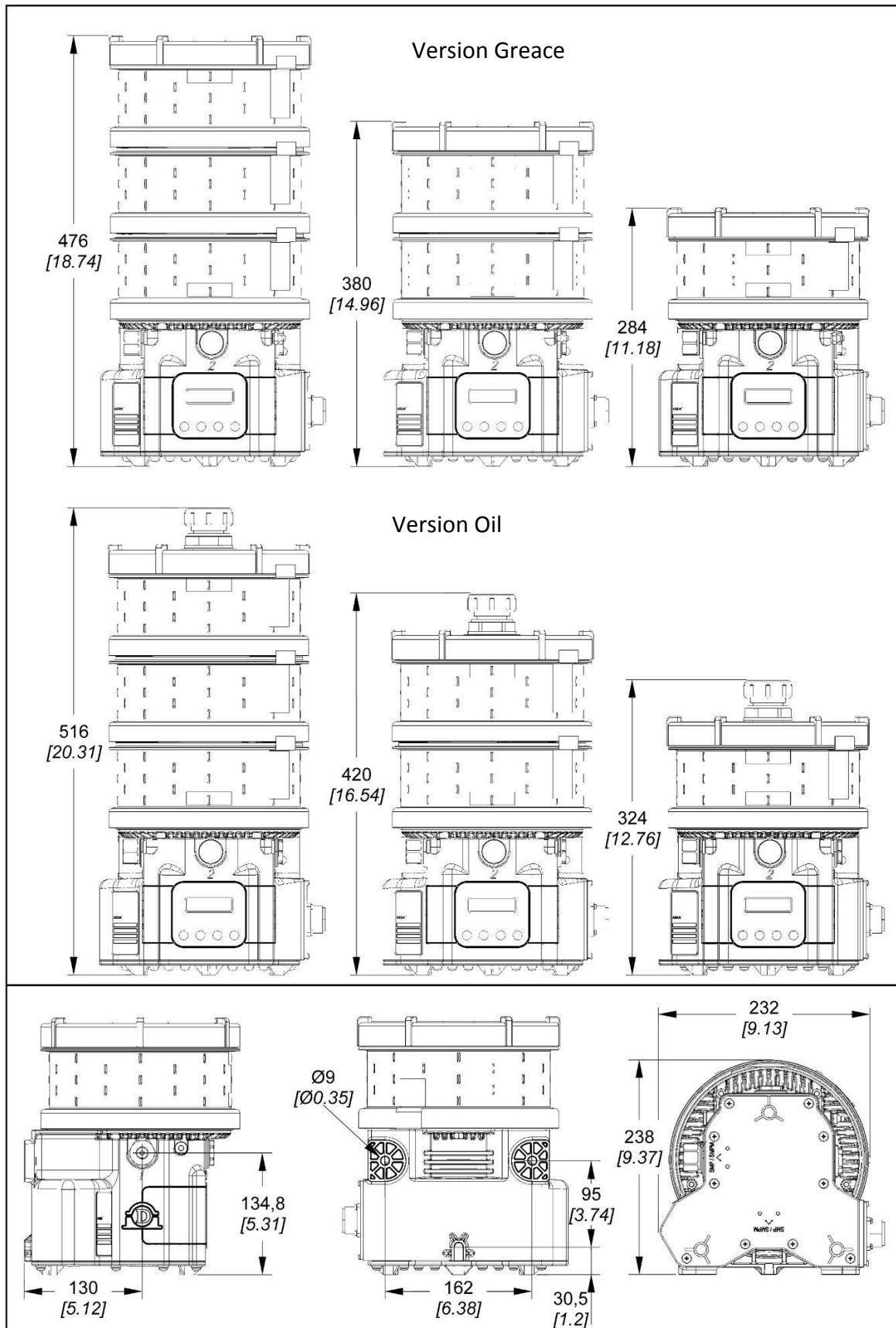

Dimensioni in mm [in].



### 13. HANDLING AND TRANSPORTATION

Prior to shipping, the equipment is carefully packed in cardboard package. During transportation and storage, always maintain the pump the right way up as indicated on the box. On receipt check that package has not been damaged. Then, storage the machine in a dry location.

### 14. OPERATING HAZARDS



**WARNING:** It is necessary to carefully read about the instructions and the risks involved in the use of lubrication machines. The operator must know the machine functioning through the User and Maintenance Manual.

#### **Power supply**

Any type of intervention must not be carried out before unplugging the machine from power supply. Make sure that no one can start it up again during the intervention.

All the installed electric and electronic equipment, reservoirs and basic components must be grounded.

#### **Flammability**

The lubricant generally used in lubrication systems is not flammable. However, it is advised to avoid contact with extremely hot substances or naked flames.

#### **Pressure**

Prior to any intervention, check the absence of residual pressure in any branch of the lubricant circuit as it may cause oil sprays when disassembling components or fittings.

#### **Noise**

Pump produces noise, not more than 70 dB(A).

### 14.1 Lubricants



**NOTE:**

The pump has been designed to operate with grease max NLGI 2 or Oil min 46cst (oil version). Always use lubricants compatible with NBR (Buna) Rubber seals.

Any residual lubricant found on new units is residual NLGI 2 test grease used during the assembly of the pump.

The following table shows the comparison between NLGI (National Lubricating Grease Institute) classification and ASTM (American Society for Testing and Materials) for greases and cSt (Centi stokes) e SUS (Saybolt Universale) for Oil

GREASE		OIL	
NLGI	ASTM	cSt	SUS
000	445 – 475	46	213.3
00	400 – 430	70	323
0	355 – 385	100	462.6
1	310 – 340	150	694.2
2	265 – 295	220	1018
For further technical information and on safety information consult the lubricant MSDS Safety data sheet or equivalent document supplied by the lubricant manufacturer.		320	1480
		450	2082
		700	3239
		1000	4628

## 15. PRECAUTIONS

The verification of conformity with the essential safety requirements and regulations of the Machine Directive is effected by means of the compilation of a check list which has been pre-prepared and is contained in the *technical file*.

The lists which are utilised are of three types:

- list of dangers (appendix A, EN 1050).
- application of essential safety requirements.
- electrical safety requirements (EN 60204).

**The following is a list of dangers which have not been fully eliminated but which are considered acceptable:**

- ◆ During installation there may be small low pressure oil seepage from the pump. Always use appropriate protective clothing, gloves and take all necessary safety precautions.
- ◆ Contact with lubricant during maintenance or filling of the reservoir. → As per previous point, correct precautions must be taken to protect from contact with lubricant.
- ◆ Moving Parts and crush danger. → All moving parts are enclosed within the pump unit. Do not open the pump unit. Appropriate danger labels are located on the pump.
- ◆ Electric shock. → All electrical connections must be carried out by a qualified electrician who has studied the connection to ensure no electrical danger.
- ◆ Abnormal operation posture. → The pump should be installed in a suitable position with ample clearance as indicated in this manual to avoid abnormal posture for the operator.
- ◆ Unsuitable Lubricant. → Lubricant characteristics are indicated on the pump and in this user manual. In any case contact a Dropsa Sales and Support engineer (**if in any doubts, contact the Technical Department Dropsa SpA**).

FLUIDS EXPLICITLY NOT ALLOWED	
Fluid	Danger
Lubricants with abrasive additives	High wear rate of contacted parts
Lubricants with silicone based additives	Seizure of the pump
Petrol – solvents – inflammable liquids	Fire – explosion – damage to seals
Corrosive products	Corrosion of the pump– injury to persons
Water	Oxidation of the pump
Food substances	Contamination of the substances themselves

# DropsA

Lubrication Systems Specialists

## DropsA S.p.A.

Via Benedetto Croce,1  
20090 Vimodrone (MI)  
Tel: +39 02 250 79 1  
Fax: +39 02 250 79 767  
[www.dropsa.com](http://www.dropsa.com)

## Copyright

© 2020 DropsA S.p.A. Via Benedetto Croce,1- 20090 Vimodrone (MI)

This documentation is protected by copyright.

All rights reserved, including translation.

All rights reserved for the case of granting of patent or registration of utility model.

No part of this document may be reproduced in any form (e.g. printed matter, copying, microfilm or any other method) or processed, duplicated or distributed in data-processing systems.

Contraventions shall be liable for damages. Reprints, even of extracts, are only permitted with the approval of DropsA S.p.A.

We reserve the right to implement technical modifications to the machine at any time in order to improve safety, reliability, function and design.

All descriptions and information in this product catalogue apply to the current state at the time it was created.

We reserve the right to change the contents of this document without notice.

We point out that the software and hardware designations used in this document and the trade names of the individual firms are subject to general protection under the law of trademarks or patent law.

The textual and drawing representation may not necessarily comply with the scope of delivery.

The technical drawings may not necessarily be drawn to scale.