

*Processing with a minimum quantity
aerosol lubrication*

Operation and maintenance manual

Original instructions

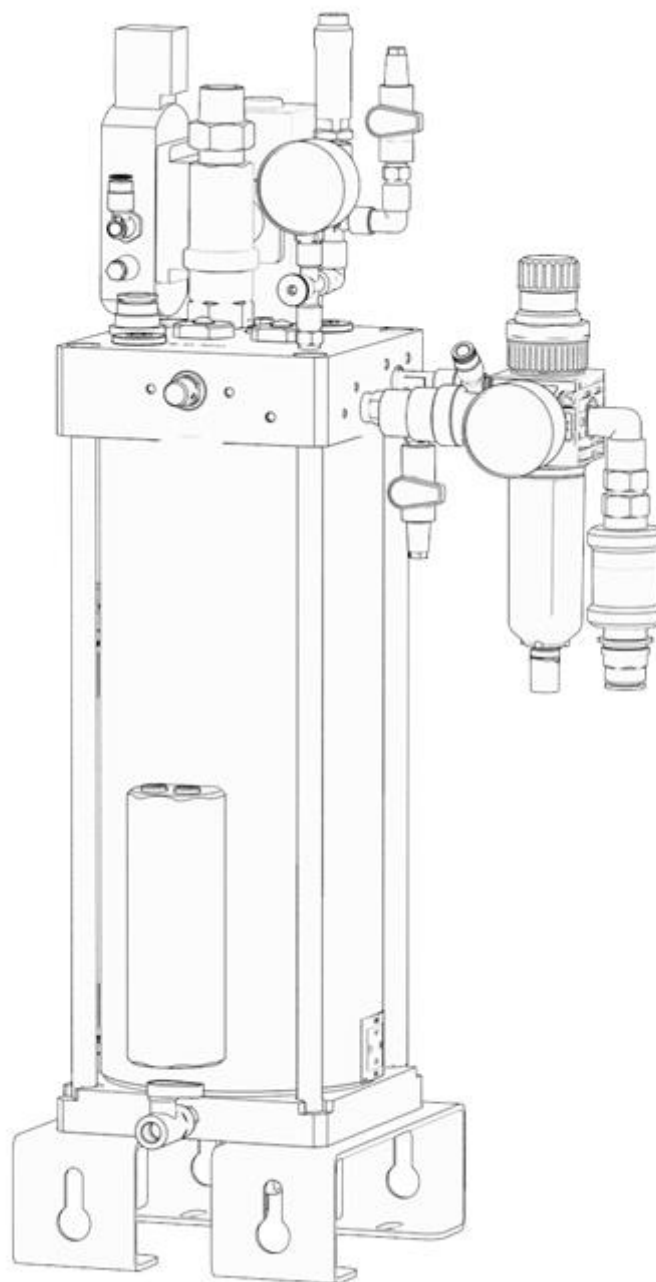

Manual drafted in compliance
with directive 2006/42

Summary

INTRODUCTION	3	7.2.2 COMPRESSED AIR CONNECTION	13
1. GENERAL DESCRIPTION.....	3	7.2.3.1 FIRST FILLING	14
1.2 SELF-ADAPTING AND HYBRID FEATURE	3	7.2.3.2 SUBSEQUENT FILLINGS.....	14
1.3 SYSTEM OPERATION SUMMARY TABLE	4	7.3 PIPES AND NOZZLES.....	15
1.3.1 MULTIPLIER ON/OFF	4	8. OPERATING INSTRUCTIONS	15
1.4 SCHEMATIC OPERATION AEROSOL FLOW RATE AND CONSUMPTION	4	8.1 MAXTREME SETTINGS.....	15
2. STRUCTURE AND OPERATION	5	8.2 START-UP - BASIC PRINCIPLES	15
2.1 LP/HP CIRCUIT OPERATION.....	5	8.3 INTERNAL LUBRICATION	16
2.2 HP CIRCUIT DRIVE WITH REMOTE CONTROL	5	8.5 ELECTRICAL CONNECTIONS MINIMUM LEVEL ...	18
3.1. MATERIALS PRESENT ON THE SYSTEM	8	8.6 PROBLEMS AND SOLUTIONS	18
3.2 AIR QUALITY	8	9. MAINTENANCE PROCEDURES	19
3.3 LUBRICANT: MAXTREME OIL.....	8	9.1 REMOVAL OF THE PRESSURE RESIDUE	19
3.4 PRESSURE	10	9.2 EXTERNAL CLEANING OF THE EQUIPMENT.....	19
4. IDENTIFYING THE MACHINE.....	10	9.3 CLEANING THE INSIDE OF THE EQUIPMENT	19
5. TECHNICAL CHARACTERISTICS	11	10. DISPOSAL	20
6. EQUIPMENT COMPONENTS.....	12	11. ORDER INFORMATION	20
7. UNPACKING AND INSTALLATION OF THE MACHINE	13	12.2 DOUBLE PNEUMATIC/ELECTRIC CONTROL NOZZLE	21
7.1 UNPACKING	13	13. TRANSFER AND TRANSPORTATION.....	22
7.2 INSTALLATION	13	14. PRECAUTIONS FOR USE.....	22
		15. CONTRAINDICATIONS OF USE	23
		Copyright.....	24

INTRODUCTION

This Operation and Maintenance Manual refers to the **MaXtreme** product for dry machining processes. You can obtain the latest version by requesting it from the Technical Sales Department, or by consulting our website <http://www.DropsA.com>.

This operation and maintenance manual contains important information for the health and safety protection of the personnel who intends to use this equipment. This manual must be read carefully and kept so that it is always available to the operators who want to consult it.

1. GENERAL DESCRIPTION

MaXtreme is designed for near-dry machining, a technology recently designed to replace traditional cooling systems and immersion in pure or emulsified oil in machining environments for chip removal, where a controlled flow of compressed air transports minimal amounts of cutting oil in "aerosol" format to the cutting surface. This technology ensures lubrication of the cutting surface and enables high-performance machining while offering longer tool life and reduced cycle times. Removing coolant from the process also provides important environmental benefits and reduces the high cost of the waste product.

The aerosol is transported to the cutting surface from the outside (via nozzles positioned around the tool) or from the inside, also known as "through the tool".

Internal lubrication is the most difficult to achieve due to the coalescence of oil particles inside the tool. **MaXtreme** solves this by generating ultra-thin particles that can pass through the rotating tool without hindrance caused by centrifugal force.

MaXtreme combines years of research and development in aerodynamic and fluid-dynamic effects to produce oil particles in an ultra-fine aerosol (diameter below the micron) that allow high-performance machining.

The double vortex solution is a revolutionary system that allows minimal lubrication and superior internal or external near-dry lubrication.

In fact, for some applications, the second nozzle optimised for higher pressures is designed to increase the aerosol flow directly on tools with minimum passage sections, thus offering better chip outflow and constant tool cooling. This option can operate in a hybrid configuration with the primary nozzle delivering constant and rich aerosol even at low flow rates, reducing the 'dead zone' at extremely low flow rates.

In addition to the Machinery Directive 2006/42/EC and, due to the increase in pressure performance up to 20 bar, **MaXtreme** is certified according to PED Directive 2014/68/EU, according to which the circuit identifies the following characteristics:

- PED RISK CATEGORY = I
- PED module: Module A
- Maximum allowable pressure: 22 Barg
- Test pressure: 36 Barg
- Permissible temperature: min 0 °C – max +60 °C
- Fluid group: Group 2

1.2 SELF-ADAPTING AND HYBRID FEATURE

The self-adaptive and hybrid functions mean that no adjustments between tool changes or complex programming configurations are necessary. The system is mounted and adapts automatically.

How it works:

the aerosol is produced using a new vortex generator that has an improved operational envelope.

A special conical exhaust nozzle design combined with a controlled surface finish fragments the oil particles by decelerating them at a controlled speed to create an aerosol with particles smaller than a micron. When the flow rates become very high (typically for very large utensils), an air pressure increase valve opens to integrate the airflow for the removal of chips and heat and therefore the density is reduced of the aerosol not required for this type of processing operation.

1.3 SYSTEM OPERATION SUMMARY TABLE

OPERATING CONDITIONS			VORTEX 1	VORTEX 2	EXTRA AIR	AEROSOL DENSITY	PRESSURE TANK
$\Delta\text{Press.} >1 \leq 2$	→	NORMAL TOOLS	ON	OFF	OFF	NORMAL	NORMAL
$\Delta\text{Press.} >2$	→	BIG TOOLS	ON	OFF	ON	LOW	LOW
$\Delta\text{Press.} =1$	→	SMALL MEDIUM TOOLS	ON	ON	OFF	NORMAL HIGH	NORMAL
$\Delta\text{Press.} <1$	→	SMALL TOOLS	OFF	ON	OFF	HIGH	HIGH

$\Delta\text{Press} = \text{supply pressure} - \text{tank pressure}$

1.3.1 MULTIPLIER ON/OFF

AIR SUPPLY PRESSURE	TANK PRESSURE DURING OPERATION	AIR MULTIPLIER
6 bar	$> 4,5$ bar	on
	$< 4,5$ bar	off

1.4 Schematic Operation Aerosol Flow Rate and Consumption

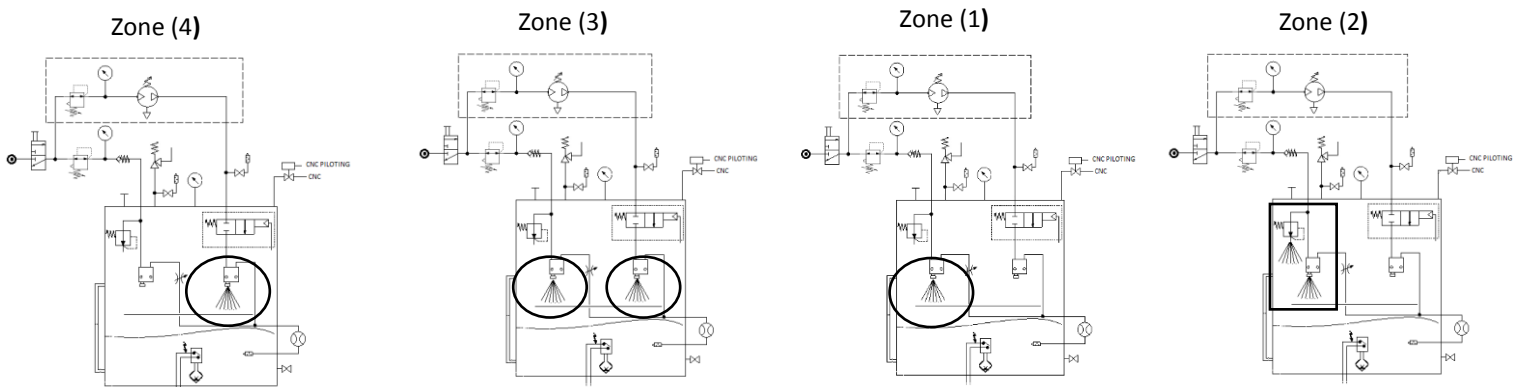
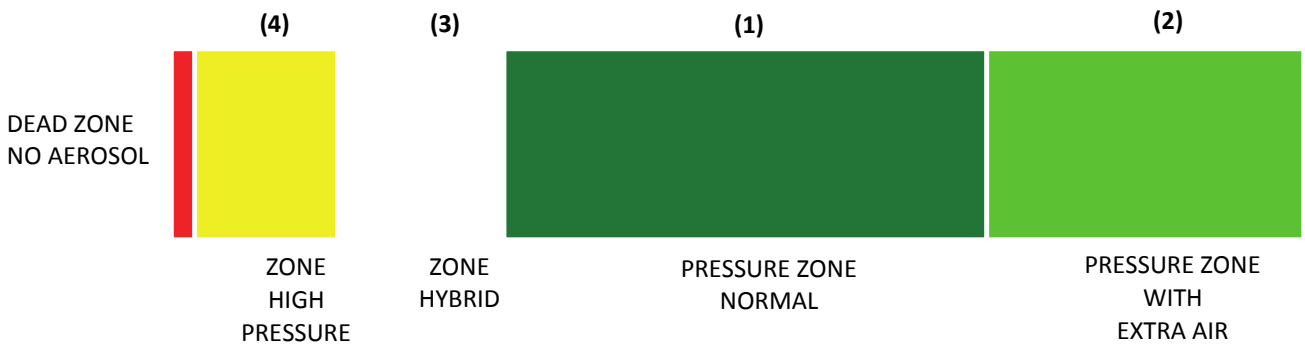
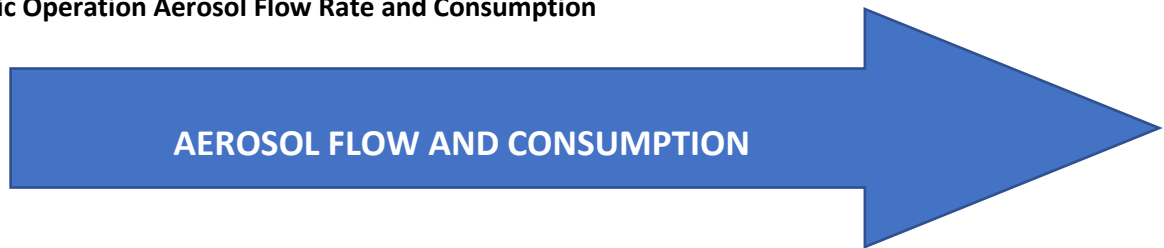

Note: External is possible In the double nozzle version. Remote HP piloting (from CNC) by inserting an ON/OFF solenoid valve

2. STRUCTURE AND OPERATION

2.1 LP/HP CIRCUIT OPERATION

The system consists of a pressurised lubricant reservoir with air. The lubricant contained in the tank (1) is sent through a pipeline inside the tank itself, to the generator nozzle (3) located inside the generator head, as a result of the pressure from the air, regulated by the valve (2).

The oil previously regulated by the valve (4) meets the airflow placed in rotation at high speed, thus splitting into micro-particles that form the aerosol mist conveying with the opening of the electro-pneumatic valve (14), towards the use in the CNC chamber.

By simply turning the valve (4), the quantity of oil introduced into the circuit is defined in % according to the position of the ball on the flowmeter (11), and the fog density is varied accordingly. (only for LP mode).

Even if totally closed, the valve (4) allows a minimum oil passage that can guarantee minimum lubrication.

The flowmeter has reading integrated for both HP / LP operating modes.

The left scale reading indicates oil supply on LP circuit, while right scale indicates oil supply on HP circuit.

In case of high airflow rates, the valve (5) feeds additional air into the tank in order to keep the pressure in the tank constant. **(Ref sheet 1 – Page 6)**

When using drills with very small lubrication diameters, there is an increase in pressure in the reservoir. This condition causes the pneumatic valve (10) to open the high-pressure duct, thus activating the multiplier (8) (if present) or external accessory connected to the port (7).

In this situation, the pressure inside the tank will tend to increase, thus closing the check valve (9). Increased pressure will facilitate the release of machining waste material, ensuring continuous tool cooling/lubrication. **(Ref sheet 2 - Page 6)**

There is no oil regulation on the HP circuit.

The oil can be filled from the port (16) or the valve (15), which also acts as an oil drain.

The max/min oil level in the tank is directly observable from the pipe (12) located on the tank.

Note: The oil level must not exceed the reference on the tank.

When topping up, make sure to exclude the mains air by acting on the valve (18), discharge the residual pressure contained in the tank by acting on the quick-release valve (22).

It is also possible to connect a minimum level alarm (13) directly to the connector under the equipment in order to prevent machining without lubricant when the system is unattended.

(Ref sheet 1 – Page 6)

Note: A single nozzle version is available in which the HP circuit is deactivated.

2.2 HP CIRCUIT DRIVE WITH REMOTE CONTROL

It is possible to mount an ON/OFF solenoid valve (21) externally controlled by the CNC that controls the intervention of external accessories.

In this case, it is preferable to deactivate the pneumatic valve (10) by completely unscrewing the adjustment screw on the valve itself. **(Ref sheet 3 – Page 6)**

In case of maintenance, it is possible to eliminate the residual pressure on the multiplier circuit by opening the valve (23) and energising the ON/OFF solenoid valve (21) if present.

ADVANTAGES:

- Reduction of the cycle time: from 25% to 80%.
- Reduction of the quantity of lubricant required
- Longer utensil life
- Improved finishing of the pieces

Application:

- Machine tools;
- Sheet metal cutting and bending machines;
- Steel mills.

Hydraulics diagram

Vortex Operation (LP)

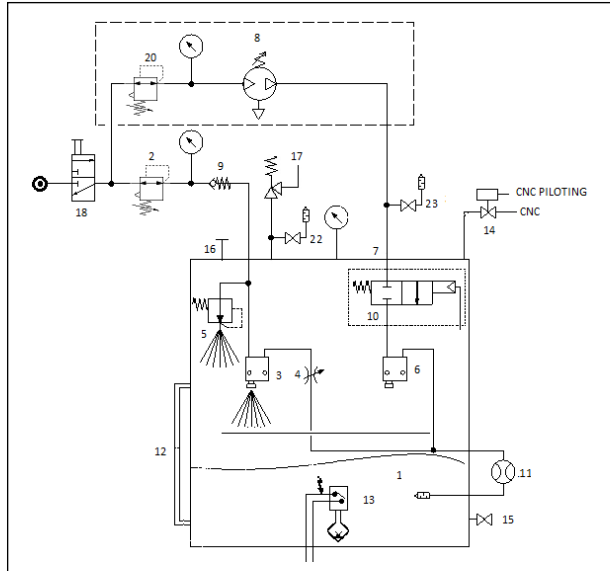

Scheme 1

Vortex (HP) operation from pneumatic pilot valve

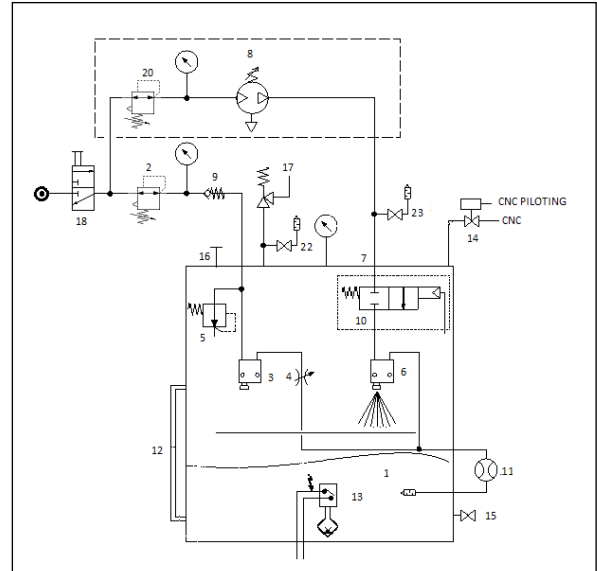

Scheme 2

Piloting (LP/HP) with solenoid valve

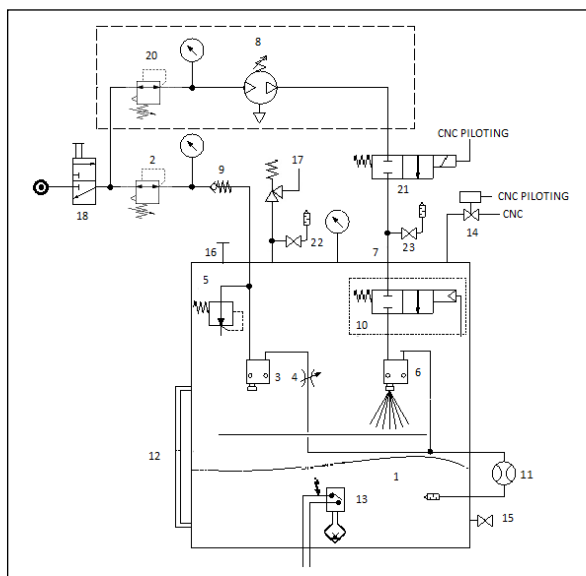























Scheme 3

3. Use safety and precautions

Before carrying out any operation it is important to read this manual. It is always recommended to respect the safety standards of the country where the equipment is installed and the need to resort to personnel specialised in the various maintenance, use, installation, etc. necessary during the life of the equipment.

Safety instructions and symbols are used in this manual in accordance with the ANSI Z535, ISO 3864 and ISO 7010 standards listed below:

Warnings table			
Warning	Damage to	Definition	Consequences
	People	Indicates a dangerous situation, which, if not avoided, death or serious injury will certainly cause.	Death or serious injury, paralytic
		Indicates a dangerous situation, which, if not avoided, death or serious injury may cause.	Potential death or serious injury
		Indicates a dangerous situation, which, if not avoided, mild or moderate injury could cause.	Moderate and mild injury possible
	Things	Indicates unrelated practices at person injury. Suggestions or other information.	Damage to things, not to people

Sumbols table					
DANGER		PROHIBITION		OBLIGATION	
	Generic danger		Generic prohibition		Generic obligation
	Laser beam danger		No smoking or use naked flames		It is mandatory to read the instructions
	Electricity danger		No entry with watches and metal objects		It is mandatory to use hearing protectors
	Hot surface danger		Do not touch		It is mandatory wear eye protection
	Danger container under pressure		It is forbidden to switch off with water		It is mandatory to ensure the ground connection
	Danger of crushing hands				It is mandatory to disconnect the current
	Explosive area danger				Protective gloves must be worn

The main rules of behavior to be observed for working with a good level of safety are the following:

- Installation, use, maintenance, etc. operations must always be carried out by qualified and trained personnel.
- It is a good rule to always wear the personal protective equipment provided without exception.
- Always carry out cleaning, adjustment and maintenance operations, making sure that all energy and compressed air supply are disconnected.
- Install the equipment away from passageways, so as to prevent it from being hit or damaged.
- Don't damage the warning sign and pictograms applied to the equipment; if they are inadvertently damaged, immediately replace them with identical ones.
- Verify the chemical compatibility of the materials with which the equipment is built with the oil you intend to use. A wrong choice could cause, in addition to damaging the equipment and pipes, serious risks for people (leakage of irritating and harmful products) and for the environment.
- Never exceed the maximum permitted operating pressure value of the equipment and the components connected to it. In case of doubt, consult the data shown on the appliance plate.
- Use only original spare parts.
- If it is necessary to replace components with others, make sure that they are suitable for operating at the maximum working pressure of the equipment.

DropsA S.p.A. declines any responsibility for damage to person or things deriving from the improper use of the equipment, from the tampering of its safety devices or from the non-observance of the safety rules at work.

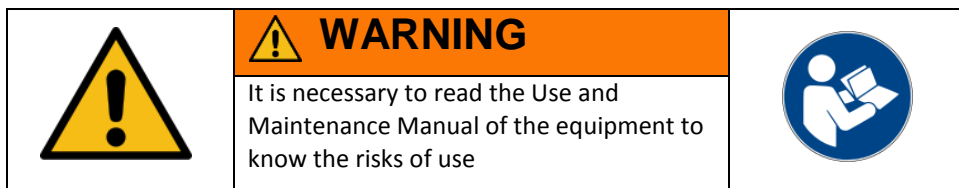

3.1. Materials present on the system

None of the materials used for the construction of the system is dangerous for the people in charge of its management (during all phases of the system's life). Specifically, the materials used for the construction of the machine are primarily:

- iron derivatives;
- plastic derivatives;
- aluminium derivatives.

Materials are in accordance with the REACH and RoHS directive.

3.2 Air quality

In order to avoid mixing water in oil in the tank and/or filling of the nozzles due to impurities present in the supply circuit itself, it is advisable to use filtered and dehumidified air according to DIN ISO 8573-1 (1.4.1).

If the equipment is used at temperatures lower than 3°C, it is necessary to use filtered and dehumidified air according to DIN ISO 8573-1 (1.3.1).

3.3 Lubricant: MaXtreme Oil

During operation, the system has been designed to use specific products for production purposes, i.e. the lubricants contained in the tank are used to carry out its activity. The only lubricant permitted by the manufacturer **DropsA S.p.A.** is a non-hazardous mixture according to the agreement (EC)1272/2008 [GHS] as described on its MSDS (Material Safety Data Sheet):

Chlorine free
Mineral oil-free

There is no water to be recycled.

Lubricating properties, anti-wear coolant

Reduces waste to dispose of and lowers consumption

For applications with:

Minimal lubrication systems



Use on ferrous and non-ferrous materials

General cutting operations of high/medium severity

In case oils other than those recommended by **DropsA S.p.A.** are used, they must belong to group 2 according to the PED Directive, and must be a non-hazardous mixture according to agreements (EC)1272/2008 [GHS], with the following physical characteristics:



Viscosity: <math><50 \text{ cSt } 40^\circ</math>
Density: 918 Kg/m^3 15 °C
Flashpoint: >250 °C

For the disposal of the oil, strictly adhere to local provisions and the related MSDS (Material Safety Datasheet).

	 DANGER	
	The lubricant used in the lubrication circuits is a fluid that is flammable at temperature >250°C. Prevent it from coming into contact with very hot parts or naked flames	

 CAUTION		
		
During oil filling operations use protective glasses and gloves to avoid direct contact with lubricant.		

3.4 Pressure

⚠ CAUTION		
		
<p>Before each intervention check the absence of residual pressures in each branch of the lubricant circuit.</p> <p>After long periods of inactivity, check the seal on all the parts subject to pressure.</p> <p>Do not subject the fittings, pipes and the parts under pressure to violent impact.</p> <p>A damaged hose or fitting is DANGEROUS, replace it.</p>		

4. IDENTIFYING THE MACHINE

On the side of the unit, there is a nameplate with the product code, supply voltages and basic features.

PRODUCT IDENTIFICATION

PART NUMBER
3135264

MAXTREME – TWO VORTEX HYBR AEROSOL

PED CAT.MOD.FLUID GR 1 – A – 2
 MAX. PRESSURE 22 BARG
 TEST. PRESSURE 36 BARG
 MAX. TEMP MIN 0 C MAX 60 C
 AIR INLET 6 BARG

WO: 0001



AN ISO 9001
APPROVED COMPANY



Dropsa Spa
Milan, IT
Year: 2020
MADE IN ITALY

Scan for Info
Scannen für Info
Telechargez-Info
Info Prodotto
扫描产品信息
сканер штрих-кода



www.DropsA.com

5. TECHNICAL CHARACTERISTICS

Technical characteristics	
*LP nozzle Air Supply:	6 Bar (87 psi)
*LP nozzle air/outlet flow rate:	35000 NI/h (W/additional air) (1236 cfh) 6 Bar
*Oil Flow rate:	220 ml/h (13.2 cu/h) 20°C
*HP nozzle Air Supply:	20 Bar (290 psi)
*HP nozzle air/outlet flow rate:	6500 NI/h (229.5 cfh)
*Nozzle oil flow HP:	9.5 ml/h (0.6 cu/h) 20°C
Min. working diameter LP nozzle (6 bar)	2 mm (7000 NI/h) (247 cfh)
Minimum working diameter HP nozzle (20 bar)	0.8 mm (3500 NI/h) (123 cfh)
Reservoir capacity:	2 litres (0.50 gallons)
Air supply hose:	Ø12mm.(0.47 in)
Usage tube:	Ø12 ÷ 16 mm (0.47 ÷ 0.6 in.)
Number of aerosol outlets:	1~3
Lubricant	DropsA recommends MaXtreme OIL for the best results
Degree of protection:	IP 65
Electro-pneumatic valve power supply: (Optional)	24VDC200mA
Operating temperature	0°C ÷ +60°C
Storage temperature	-10°C ÷ +80°C
Noise (distance 1mt)	70 dB "A"
Escape valve:	22 bar
Reservoir pressure gauge:	0~25 Bar
<i>All the values on the technical characteristics refer to Ø12 in/out connections</i>	
<i>* The value is variable depending on the outlet Ø or the tool chosen for HP nozzle version</i>	

6. EQUIPMENT COMPONENTS

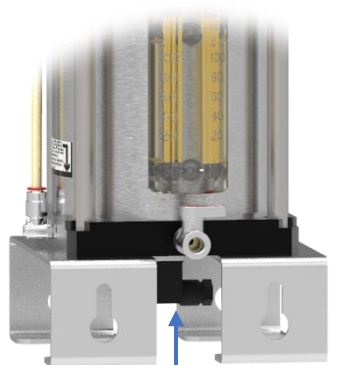
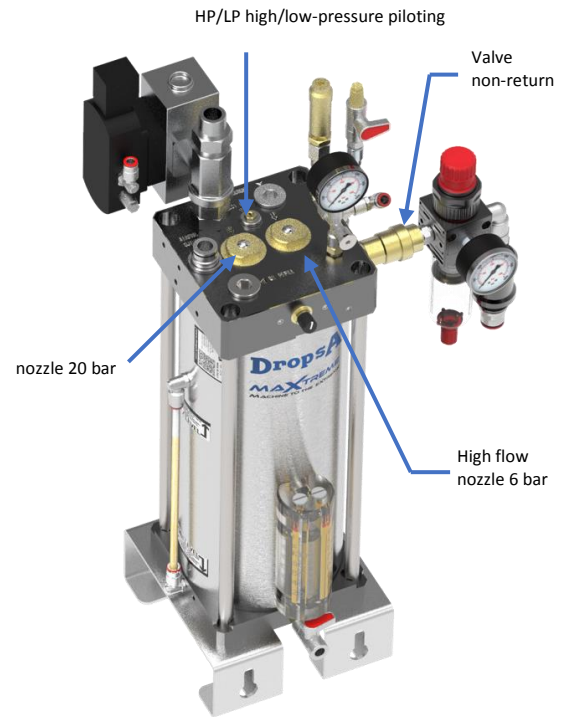
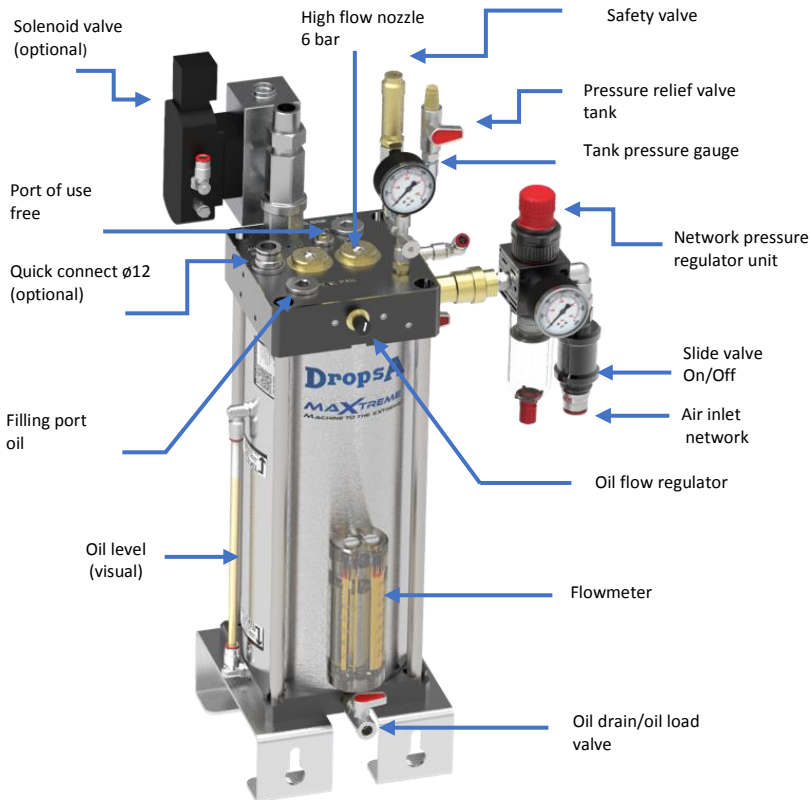

Minimum level alarm connector

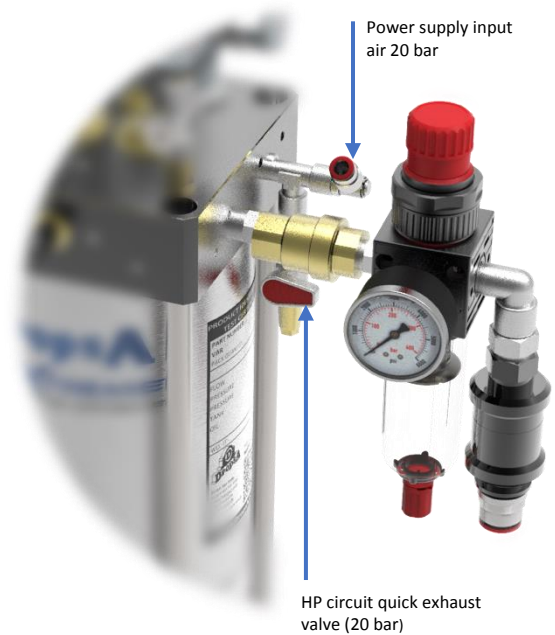

7. UNPACKING AND INSTALLATION OF THE MACHINE

7.1 UNPACKING

Once you have identified the suitable place for installation, open the packaging and remove the equipment. Check the unit for damage during transport and storage. The packing material does not require special disposal precautions as it is in no way dangerous or pollutant. For disposal, refer to local regulations.



7.2 INSTALLATION

The equipment can be installed in two ways:

- Attach the equipment to the structure of the machine tool. Take care not to install the equipment in an environment that is particularly prone to strong vibration or oscillation.
- Install the equipment in the vicinity of the machine tool, ensuring that it is a suitable environment for this type of equipment.

Strictly follow the following rules:



- In order to avoid malfunctions, always position the equipment vertically.
- **NEVER** turn the equipment upside down.
- For filling and control of the system, place the equipment in an easily accessible environment.

	 NOTICE	
	<p>Place the equipment on the machine vertically and in an easily accessible location. NEVER flip the equipment</p>	

The operator is responsible for any damage caused to the MaXtreme equipment by improper installation.

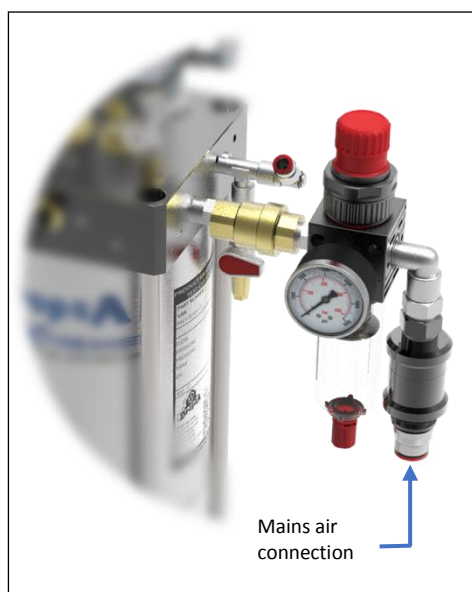
7.2.2 COMPRESSED AIR CONNECTION



	 WARNING
	<p>The compressed air connection must be made by competent and qualified personnel. For safety reasons, the compressed air pressure at the mains air connection must never exceed 6 bar.</p>

7.2.3 TANK FILLING

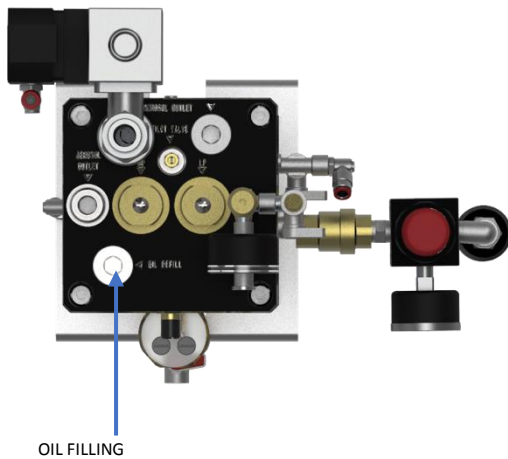

7.2.3.1 FIRST FILLING

During the first filling, it must be ensured that there is no residual pressure inside the tank. (**Ref. par.9.1**). The oil must be poured into the tank through the special inlet (OIL RECHARGE).

The "maximum" sign (B) on the filling indicator must under no circumstances be exceeded.

7.2.3.2 SUBSEQUENT FILLINGS

When the oil reaches the "minimum" level (A), **MaXtreme** must be refilled. If the unit is in operation, switch it off and eliminate the residual pressure (**Ref.par.9.1**). Then proceed as described in **7.2.3.1 FIRST FILLING UP**.

If connected in analogue mode with the minimum level alarm, the numerical control would block the system. In that case eliminate the residual pressure, (**Ref.par.9.1**), and proceed as described in paragraph

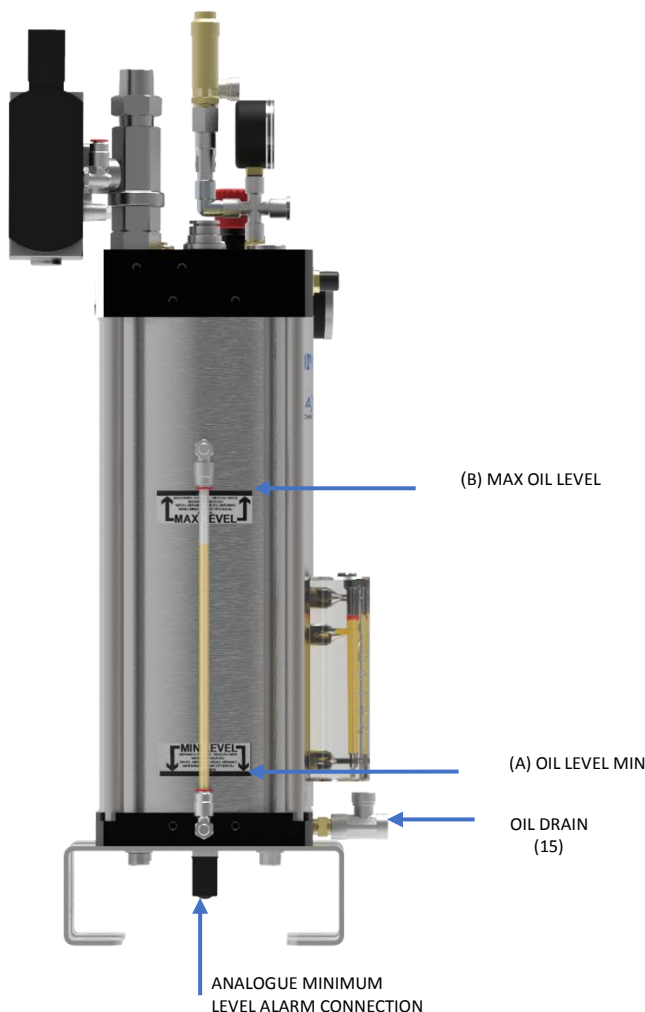

7.2.3.1 FIRST FILLING UP

	! WARNING
	<p>During the filling operations, always disconnect the system from the compressed air by acting on the manual sliding valve and on the multiplier supply pressure reducer by turning it fully counterclockwise.</p> <p>When filling the tank, never exceed the "maximum"(B) level.</p>

	! NOTICE
	<p>Use the same oil in case of subsequent fillings, otherwise make sure to remove all traces of the lubricant previously used via the oil drain cock.</p> <p>Only then fill the tank with the new oil and operate the equipment.</p> <p>DropsA declines all responsibility for the incorrect operation of the equipment.</p>

Recommended lubricants: MaXtreme Oil

7.3 PIPES AND NOZZLES

The recommended pipes have an external diameter of 12 mm for the whole part of the system that can be covered with this diameter.



The length of the aerosol pipeline should be kept as short as possible. The longer the aerosol pipeline length, the greater the pressure and aerosol losses.

The aerosol lines should be laid as linearly as possible, especially avoiding "narrow bows", otherwise there is a danger of lubricant precipitation. If deflection connections cannot be avoided, they must have a radius of at least 200 mm.

The aerosol pipeline should have a continuous slope in the direction of the machine. Downward curves should be avoided as much as possible since lubricant could accumulate at these points if the machine is stopped.

The feeding of aerosols into spindles or rotating tools should be carried out as far as possible in the axial direction. In the case of radial adduction, it can happen, especially at high spindle speeds, that the lubricant is "centrifuged out", thus causing a separation of the aerosol.

This is particularly the case when used with small tools with high rotational speed.

	WARNING	
	 WARNING The equipment must operate according to the parameters indicated in the technical characteristics.	

8. OPERATING INSTRUCTIONS

The same general procedures and precautions typical of the installation of traditional lubrication and cooling systems must be observed.

8.1 MaXtreme SETTINGS



Refer to the figure in paragraph 6

- Air quantity: by air pressure regulator with pressure gauge.
- Oil quantity: through the flow control valve.

8.2 START-UP - BASIC PRINCIPLES

Refer to the figure in the paragraph. 6

- a) Close the air pressure regulator valve completely by turning the ring nut counterclockwise.
- b) Connect the compressed air hose via the appropriate mains air connection.
- c) Mount the tool in the machine.
- d) Open the following valves:
 - Manual on/off slide valve for compressed air by moving it horizontally to (ON).
 - Turn the ring nut of the air pressure regulator until you get 6 bar reading on the pressure gauge.
- f) Open operating valve.
- g)

	NOTICE
	 NOTICE During operation in HP mode, the percentage of oil indicated on the flowmeter may be at a maximum of 20%. LP flow rate in percentage of oil indicated on the flowmeter may be at a maximum of 100%. The oil flow rate of the HP nozzle is not adjustable.

8.3 INTERNAL LUBRICATION

MaXtreme is used for internal lubrication work: the aerosol is brought inside the tool via the spindle.



In such a situation, it is suggested to follow the following instructions:

- The spindle must be suitable for the type of application in question (dry machining).
- Some spindles have a non-return valve. This could be a problem due to the relatively low working pressure of the system. A valve modification may be required. Ask **DropsA** for advice.
- Make sure that the hose used to transport the oil does not have any alterations such as cross cuts, cracks or cracks. In this case, the lubricant would be deposited in the cracks and would not reach the correct amount at the cutting point.
- Be advised when choosing the ideal tool for minimal lubrication.
- Ensure that there is no excessive bending or shrinkage (diameter reduction) of the piping in the lubrication line. This would result in a deposit of lubricant in these areas preventing the aerosol from reaching the machining centre.
- Make sure that aerosol mist comes out of the tool.
- The workpiece must be positioned at a maximum distance of 40 mm (1.57 in.) from the outlet of the minimum lubrication channel to ensure the formation of a thin film of lubricant.
- The amount of aerosol mixture must be appropriate for the type of processing. If necessary, change the flow quantity through the oil flow control valve. (**Ref. par. 6**)



NOTICE

MaXtreme is capable of effective lubrication through very small tool channels (capillaries); in this case, it may be necessary to configure the system for aerosol pressure up to 20 Bar.

For a greater system efficiency, we recommend the use of the same tools or with a similar internal lubrication passage, if used at the same time.

8.4 INDICATIVE CONSUMPTION

FLOW RATE AIR/OIL NORMAL PRESSURE 6 BAR VORTEX 1

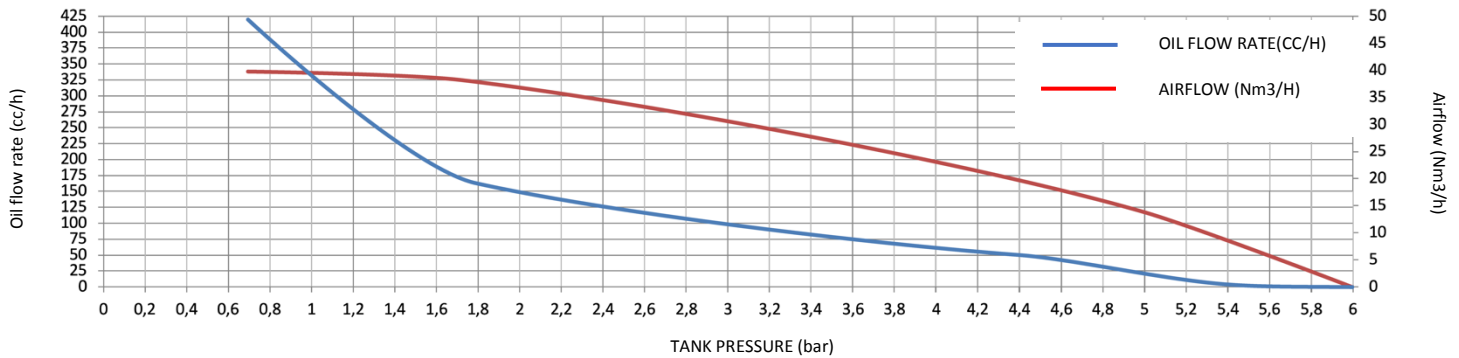

HIGH AIR/OIL FLOW RATE PRESS 20 BAR VORTEX 2

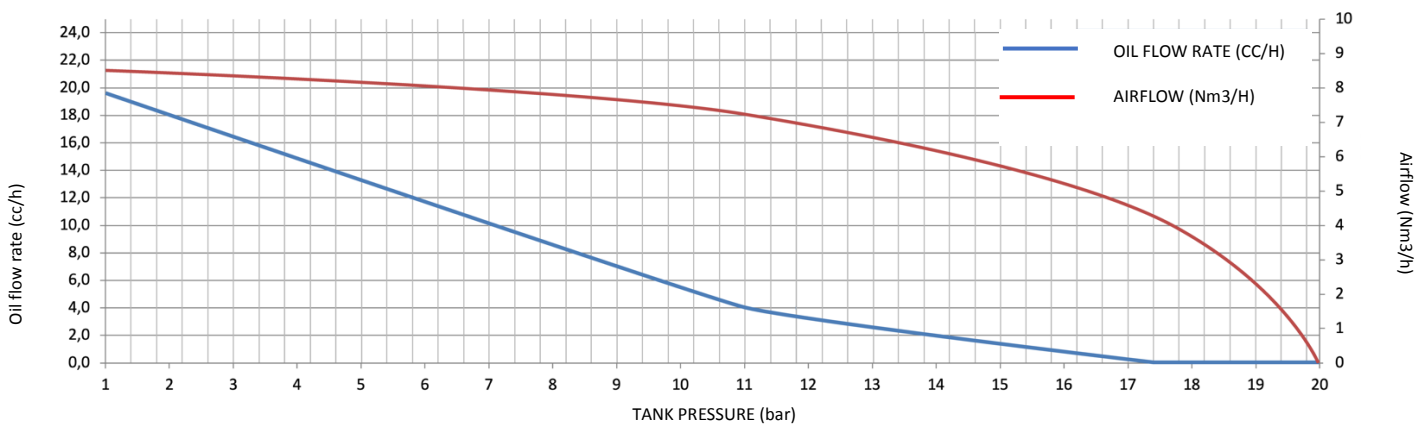

*not applicable to MaXtreme one

COMBINED AIR/VORTEX OIL FLOW RATE

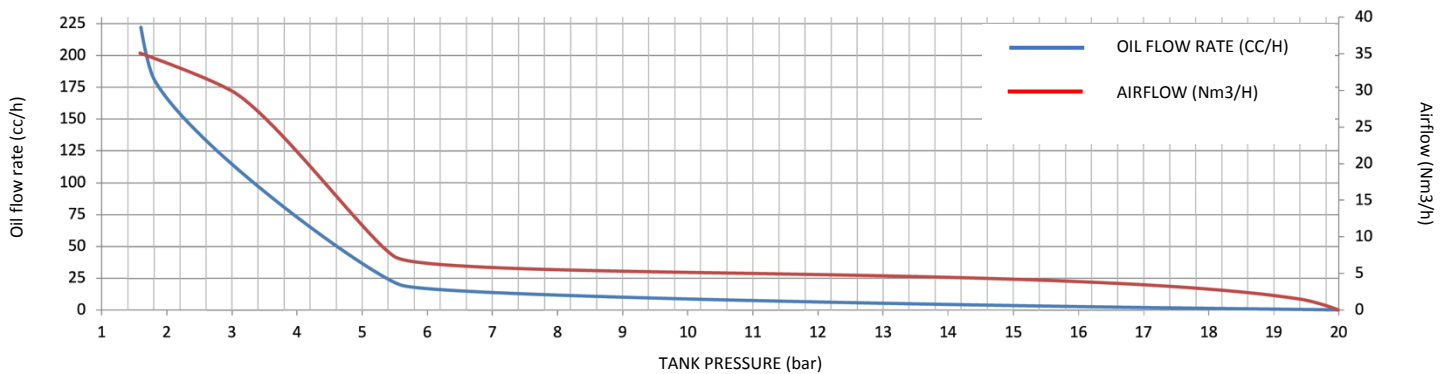

*not applicable to MaXtreme one

Maxtreme oil viscosity: <50cSt 40°
Test temperature: 20°C





NOTICE



For optimal performance, the use of a heater is recommended when used at temperatures <20°C.

8.5 ELECTRICAL CONNECTIONS MINIMUM LEVEL

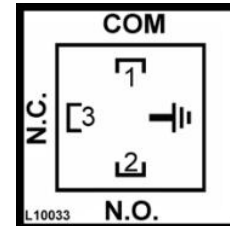
- Connect the minimum level by setting the circuit to N.O without the presence of oil.
- The plate is placed on the tank.





8.6 PROBLEMS AND SOLUTIONS





	 WARNING	
	The unit may only be opened and repaired by authorised DropsA personnel.	

Below is a troubleshooting table highlighting the main failures, probable causes and possible solutions. If, even after consulting the diagnostic table, the problem has not been solved, do not proceed with troubleshooting by disassembling parts of the machine, but contact the Technical Office **DropsA** and report the anomalies found with a detailed description.

TROUBLESHOOTING TABLE		
ANOMALY	CAUSE	REMEDIAL ACTION TO BE TAKEN
When the working solenoid valve is activated, no air comes out.	No air supply	Check that you have pressure in the tank. Make sure that there is mains air and that all valves and pressure reducers are correctly set.
	Faulty solenoid valve	Contact service centre DropsA S.p.A
Activating the working solenoid valve does not generate aerosols.	Faulty solenoid valve	Contact service centre DropsA S.p.A
	The tank pressure is equal to the supply pressure.	Increase the air passage hole on the unit to be lubricated
	Oil missing	Check the oil level
	Lubricant below the minimum level in the tank	Fill the tank with new lubricant.
The multiplier always works below 4.5 bar	Actuation valve	Tighten the screw located on the actuation valve until the multiplier has almost achieved shutdown.
The multiplier doesn't work, and the tank pressure is the same as that of the network	Actuation valve	Unscrew the screw located on the actuation valve until the multiplier resumes normal operation. (The valve will then be withdrawn. Please see the previous point)

	 WARNING	
	Make sure that the air supply is disconnected before performing any maintenance work.	

9. MAINTENANCE PROCEDURES

 CAUTION		
		
<p>Before any operation, check for the absence of any residual pressure in all branches of the lubricant circuit.</p> <p>After long periods of inactivity, check the seal on all the parts subject to pressure.</p> <p>Do not subject the fittings, pipes and the parts under pressure to violent impact.</p> <p>A damaged hose or fitting is DANGEROUS, replace it.</p> <p>We recommend using only original spare parts.</p>		

The units have been designed and built in such a way as to require minimal maintenance. In order to simplify maintenance, we recommend installing them in a position that is easy to reach. (Ref. par. 7.2).

- Periodically check the joints of the lines for any leaks.
- Check the oil level periodically and refill the oil via the filler plug if necessary.

The machine does not require special tools for any check and/or maintenance operations. We recommend using tools and personal protection equipment suitable for use with reference to Legislative Decree 81/2008, and in good condition (in accordance with the prevailing regulation) in order to prevent damage to personnel or parts of the machine.

9.1 REMOVAL OF THE PRESSURE RESIDUE

Refer to the figure in the paragraph. 6

- Remove mains pressure by acting on the on/off slide valve.
- Remove the mains pressure on any external accessory.
- Open the quick exhaust valve on the head, making sure that the pressure gauge marks "0" bar.
- Open the quick exhaust valve on the circuit at 20 bar.

9.2 EXTERNAL CLEANING OF THE EQUIPMENT

MaXtreme Cleaning



- Eliminate residual pressure. (Par. 9.1)
- Clean with a damp cloth; do not use steel brushes.
- Do not wash with running water.
- Do not use aggressive cleaning agents, detergents, chemicals.
- After cleaning, dry with a soft cloth.
- Reposition the equipment. Do not connect the compressed air source until all other connection operations have been completed.

9.3 CLEANING THE INSIDE OF THE EQUIPMENT

Under normal conditions of use, internal cleaning is not necessary. In case it becomes indispensable:

- Eliminate residual pressure. (Par. 9.1)
- Decompress the outgoing pipes as well.
- Open the oil drain cock.
- Collect the oil in a basin.

- Close the oil outlet. Fill the unit with new lubricant (approx. 2 lt - 0, 44 gallons- as described in 5.3.1.)
Put the equipment back into operation (see Chap. 8. Instruction for use)

	! WARNING	
	Before any maintenance operation, make sure that the pneumatic supply is disconnected.	

10. DISPOSAL

During maintenance on the machine, or in the event of its demolition, do not dispose of contaminated parts into the environment. See local regulations for their correct disposal. Upon demolition of the machine, the identification label and any other document must be destroyed.

11. ORDER INFORMATION

Part number	Description
3135263	Maxtreme -1 with minimum level, single nozzle (HP circuit deactivate)
3135264	Maxtreme - with minimum double-level nozzle

Accessories	
Part number	Description
3155187	Solenoid valve for aerosol control
0295188	Air multiplier kit
0295189	On/Off solenoid valve kit for high-pressure circuit
0295272	On/Off solenoid valve kit for low-pressure circuit

Spares parts	
Part number	Description
0020685	Pressure adjustment valve 0~10 Bar
3292142	0-25 Bar pressure gauge
3155312	Safety valve
3089043	Aircheck valve

Consumable Products	
Part number	Description
3226692	Maxtreme - Oil 22 Lt
3226693	Maxtreme - Oil 206 Lt
3226694	Maxtreme - Oil 980 Lt

12.2 DOUBLE PNEUMATIC/ELECTRIC CONTROL NOZZLE

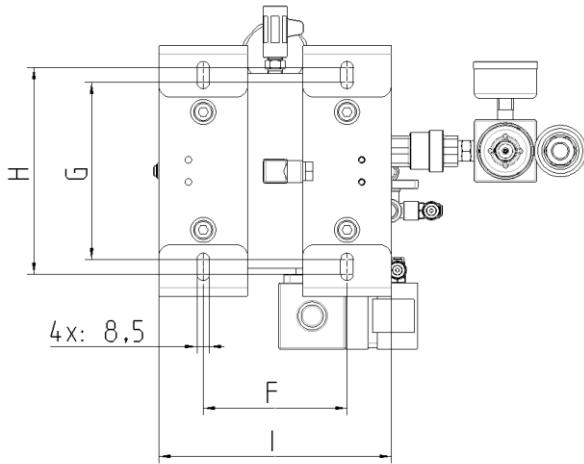

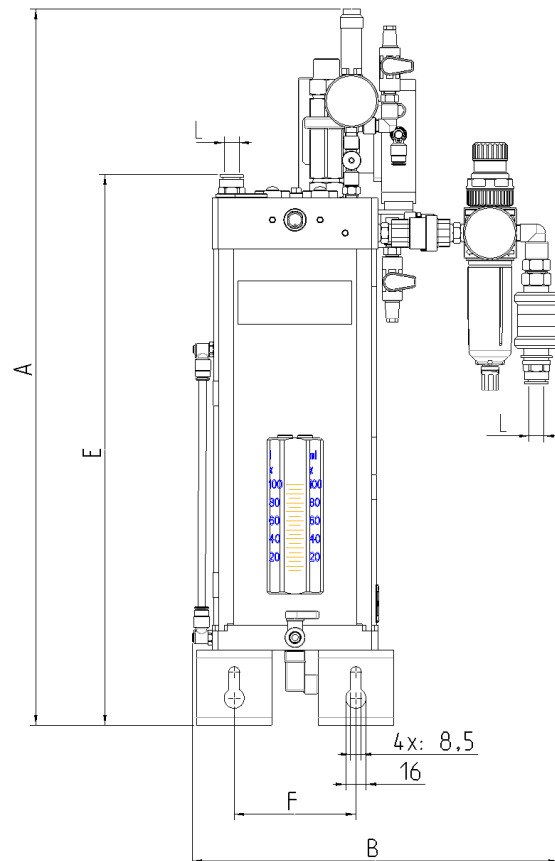
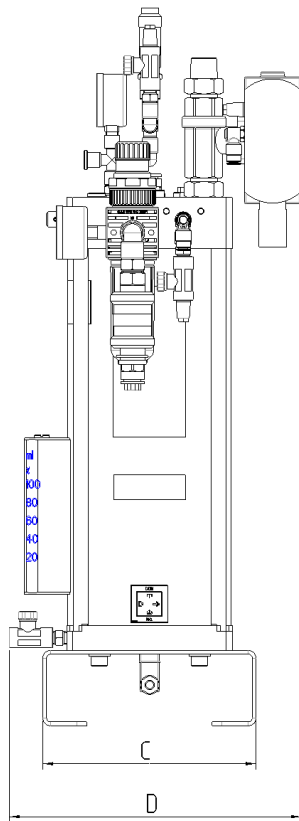

Dimensions in mm (inches)

A	570 (22.5)
B	292 (11.5)
C	170 (6.69)
D	232 (9.1)
E	439 (17.28)
F	97 (3.81)
G	120 (4.72)
H	140 (5.51)
I	157 (6.18)
L	TUBO \varnothing 12 / NIPPLO G1/2"





13. TRANSFER AND TRANSPORTATION

Before shipment, the unit is carefully packed in a cardboard box. Upon receipt, check the packaging for damage and store the equipment in a dry place.

	 NOTICE
	<p>Machine components can withstand temperatures, during storage, from -10 to +80 °C;</p> <p>In order to avoid damage, the machine must be started when it has reached a temperature of 0 °C.</p>

14. PRECAUTIONS FOR USE

It is necessary to carefully read the warnings about the risks involved in the use of a unit for lubricants. The operator must know how it works and must clearly understand the dangers associated with pumping oils under pressure.

	 WARNING
	<p>Verify the chemical compatibility of the materials with which the unit is built with the fluid you intend to pump. A wrong choice could cause, in addition to damaging units and pipes, serious risks for people (leakage of products that are irritating and harmful to health) and for the environment.</p> <p>Never exceed the maximum operating pressure value allowed by the unit and by the components connected to it. If you have any doubts, consult the data on the machine's plate.</p> <p>Use only original spare parts.</p> <p>If it is necessary to replace components with others, make sure they are suitable for operating at the unit's maximum operating pressure.</p> <p>Never try to stop or divert any leaks with your hands or with other parts of the body.</p>





15. CONTRAINDICATIONS OF USE

Compliance with the essential safety requirements and machine directive provisions has been checked through the completion of checklists already drafted and contained in the *technical file*.

Two types of lists were used:

- Risk assessment (UNI EN ISO 12100:2010).
- Compliance with essential safety requirements (Machine Directive -CE 06/42).

The hazards that have not been entirely eliminated, but that have been deemed acceptable, are listed below:

 CAUTION		
		
<p>Low-pressure oil splashes are possible during maintenance (for this purpose, maintenance activities must be carried out using suitable PPE).</p> <p>Electrocution: This can occur only in the event of serious negligence by the user who, however, is qualified.</p> <p>Inappropriate Posture: The correct overall dimensions and the installation methods are indicated in this manual.</p> <p>Use of unsuitable lubricant: the characteristics of the lubricant can be found both on the unit and on this <i>User and Maintenance Manual</i> (in case of doubt, please contact the Technical Department DropsA S.p.A.)</p>		

DropsA

Lubrication Systems Specialists

DropsA S.p.A.

Via Benedetto Croce,1
20090 Vimodrone (MI)
Tel: +39 02 250 79 1
Fax: +39 02 250 79 767
www.dropsa.com

Copyright

© 2020 DropsA S.p.A. Via Benedetto Croce,1- 20090 Vimodrone (MI)

This documentation is protected by copyright.

All rights reserved, including translation.

All rights reserved for the case of granting of patent or registration of utility model.

No part of this document may be reproduced in any form (e.g. printed matter, copying, microfilm or any other method) or processed, duplicated or distributed in data-processing systems.

Contraventions shall be liable for damages. Reprints, even of extracts, are only permitted with the approval of DropsA S.p.A.

We reserve the right to implement technical modifications to the machine at any time in order to improve safety, reliability, function and design.

All descriptions and information in this product catalogue apply to the current state at the time it was created.

We reserve the right to change the contents of this document without notice.

We point out that the software and hardware designations used in this document and the trade names of the individual firms are subject to general protection under the law of trademarks or patent law.

The textual and drawing representation may not necessarily comply with the scope of delivery.

The technical drawings may not necessarily be drawn to scale.